

**SAMSUNG**

# TECHNICAL MANUAL

## NX-828 (For EUROPEAN)





## **EC DECLARATION OF CONFORMITY**

For the following named product :

**KEY TELEPHONE SYSTEM, NX-828**

We hereby declare, that all major safety requirements, concerning to Electro-Magnetic Compatibility (89/336/EEC) are fulfilled, as laid out in the guidelines set down by the number states of the EEC commission.

This declaration is valid for all samples that are part of this declaration, which are manufactured according to the production chart appendix.

This standards relevant for the evaluation of Electro-Magnetic Compatibility requirements are as follows ;

EN55022 (1987 LIMIT CLASS B)

Radiated Emission : 30 MHz ~ 1 GHz

Conducted emission : 150 MHz ~ 30 MHz

EN60555 ( 1992 LIMIT CLASS B)

Power Harmonics : 2nd ~ 40th Harmonics

EN50082-1 (1992)

Radiated Susceptibility : 27 MHz ~ 500 MHz (3V/m)

ESD : Air Discharge 8KV

EFT/BURST : AC Power Lines (1000V / 5KHz)  
I/O Lines (500V / 5KHz)

IEC950(1991) Second Edition with Amendment 1(1992) and 2(1993) ;

EN60 950(1991) with Amdts. 1 & 2 : EN41 003 and National Deviations



**ELECTRONICS**

## **PUBLICATION INFORMATION**

SAMSUNG ELECTRONICS Co.  
reserves the right to revise information in this  
publication for any reason without prior notice.

SAMSUNG ELECTRONICS Co.  
also reserves the right to make changes in equipment  
design or components as engineering and manufacturing  
may warrant without prior notice .

COPYRIGHT © 1998 SAMSUNG ELECTRONICS Co.

All rights reserved. No part of this manual may be reproduced  
in any form or by any means --- graphic, electronic or  
mechanical, including recording, taping, photocopying or  
information retrieval systems --- without express written  
permission of the publisher of this material.

# **NX-828**

ELECTRONIC KEY/HYBRID  
TELEPHONE SYSTEM

## **TECHNICAL MANUAL**

INCLUDES :

**GENERAL DESCRIPTION SECTION**

**INSTALLATION SECTION**

**FEATURE SECTION**

**PROGRAMMING SECTION**

**APPENDIX SECTION**

**BACK-UP DATA SHEETS**

Every effort has been made to eliminate errors and ambiguities in the information contained in this manual. Any questions concerning information presented here should be directed to SAMSUNG ELECTRONICS Co., 9th Fl. Joong-Ang Daily News Bldg. 7, Soonwha-Dong, Chung-ku, Seoul, Korea C.P.O. Box:2775, Tel: (02)751-6508. SAMSUNG ELECTRONICS Co. disclaims all liabilities for damages arising from the erroneous interpretation or use of information presented in this manual.



# GENERAL DESCRIPTION

# TABLE OF CONTENTS

## GENERAL DESCRIPTION

<b>NX-828 General System Diagram .....</b>	<b>1 - 1</b>
<b>1. System Overview .....</b>	<b>1 - 2</b>
<b>2. System Configuration .....</b>	<b>1 - 2</b>
<b>3. Hardware Description .....</b>	<b>1 - 3</b>
3.1 Key Service Unit (KSU) .....	1 - 3
3.2 Option Cards .....	1 - 3
3.3 Station Equipment .....	1 - 4
<b>4. Specifications .....</b>	<b>1 - 5</b>
4.1 Electrical Specifications .....	1 - 5
4.2 Dimensions and Weights .....	1 - 5
4.3 Environmental Limitations .....	1 - 5
4.4 Cable Requirements .....	1 - 5
4.5 System Tones and Rings .....	1 - 6
4.6 Keypad LED Indications .....	1 - 7

# NX-828 General System Diagram

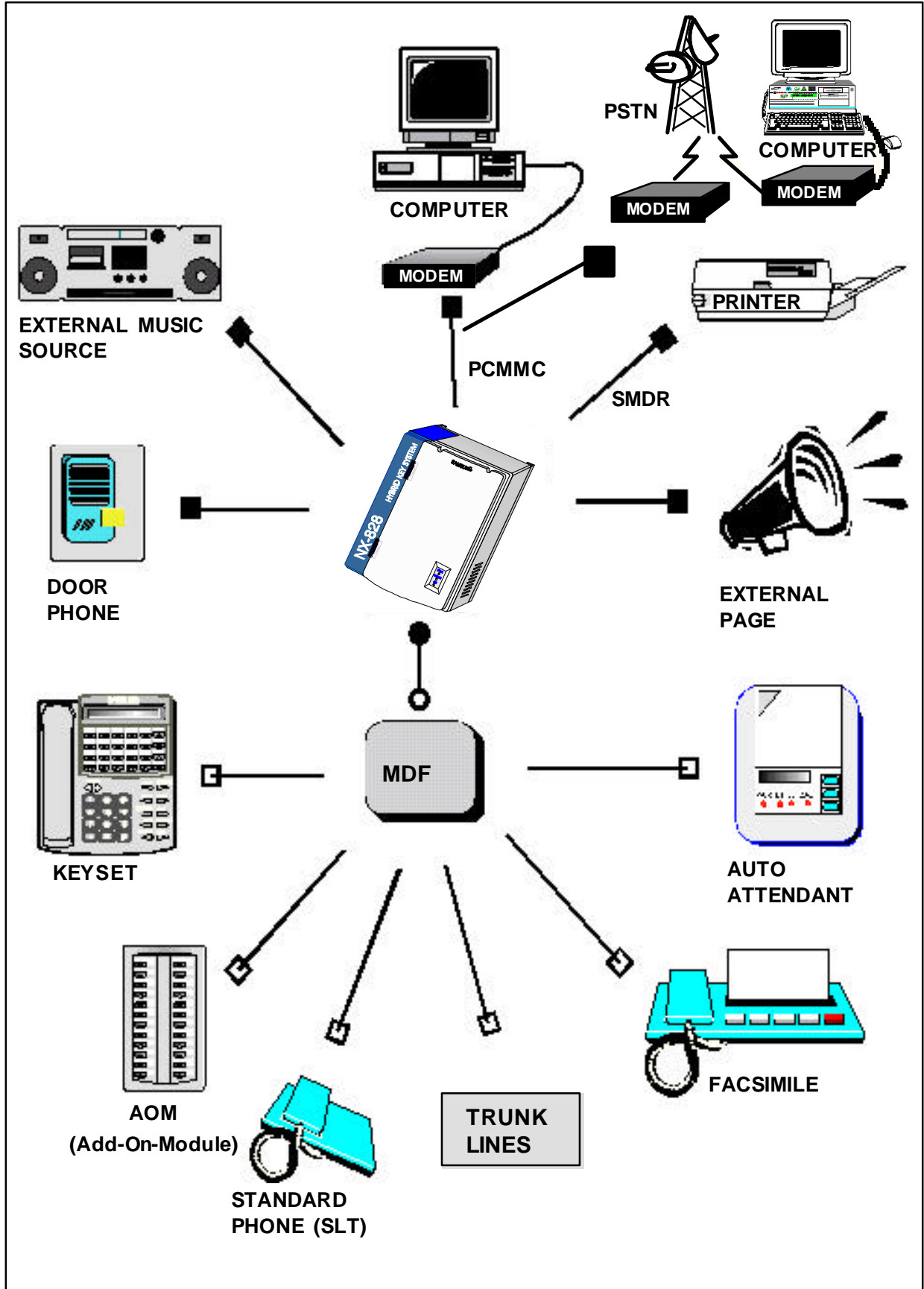

# 1. System Overview

The NX-828 system is an analogue telephone system designed for small to medium-sized businesses and for meeting CE (EMC + safety) regulations as well as the related PTT regulations. The system has a maximum capacity of forty (40) ports, being the sum of telephone lines and stations-the combinations of which are flexible. Comprising only a Key Service Unit (KSU), option cards, electronic keysets and conventional single line telephones, the system offers small or medium-sized business user's the flexibility and control of telephone communications. A powerful HM64180R1 microprocessor digitally controls all speech paths and system functions. The operating program with default memory is stored in non-volatile ROM 27C 020. Customer data is stored in RAM 681000 and is protected by a rechargeable Ni-Cd battery for up to seven day's continuous loss of system power.

# 2. System Configuration

The basic KSU comes equipped to operate four (4) telephone lines and twelve (12) stations. Stations from #1 to #4 are assigned to keysets, and stations from #5 to #12 are assigned to single line telephones. The NX-828 system has several types of option card: the NX-4TRK, NX-8KLI, NX-8SLI and NX-4OPX card can be installed in any slot of the three expansion slots. By combining these cards, the system can be increased to its maximum capacity of forty (40) ports. Optionally, the NX-SMDR/R-MMC and NX-DPH/PAGING cards can be installed on the base board for value-added features.

The NX-SMDR/R-MMC card is the serial interface card for SMDR and Remote MMC, and the NX-DPH/PAGING card is the door phone and external paging interface card. The NX-MPD Hybrid IC (50Hz, 12 or 16KHz) can be installed on the base board and the NX-4TRK option card for four (4) trunk ports up to a maximum of four per card. The chart below describes configurations using option cards.

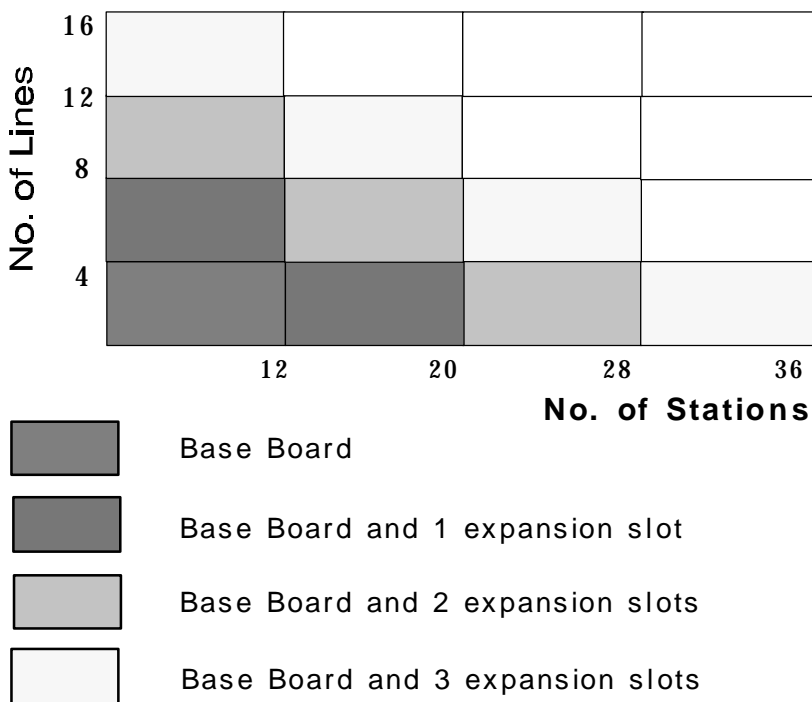

You may connect up to 24 keystations to the system. More than 24 KLI connections may cause problems with system features.

## 3. Hardware Description

### 3.1 Key Service Unit (KSU)

The **NX-828** system is a single cabinet, wall mounted, metal-cased unit containing the following:

• **Power Supply**

- System main DC regulator from AC 230V, 50Hz
- Sinusoidal ring signal generator
- Battery charging/ Re-charging circuitry
- DC power regulator for single line telephones
- +12V DC power regulator and -5V DC power regulator

• **Connection Board**

• **Base Board**

- Four (4) loop start trunk line interface circuitry with Metering Pulse Detectors (optionally, 50Hz, 12kHz or 16kHz)
- Four (4) keyset interfaces and eight (8) single line telephone interfaces
- 16 speech paths
- Internal music source and external music interface
- Two (2) power failure transfers (trunk #1, #2 - station #11, #12)
- Memory back-up battery
- Real-time clock
- Four (4) connectors for Metering Pulse Detectors related to four (4) trunks
- Connector for NX-DPH/PAGING card and NX-SMDR/R-MMC card
- Three (3) expansion slots
- +5V DC power regulator

### 3.2 Option Cards

- **NX-4TRK** card provides four (4) loop start trunk interfaces, with Metering pulse Detectors (optionally, 50Hz, 12KHz or 16KHz).
- **NX-8KLI** card provides eight (8) ports for keysets.
- **NX-8SLI** card provides eight (8) single line telephones indoors.
- **NX-4OPX** card provides four (4) line telephones outdoors.
- **NX-SMDR/R-MMC** card provides two serial ports for SMDR and Remote MMC.
- **NX-DPH/PAGING** card provides two door phone interface and one external paging interface.

- iü **MPD Hybrid IC** can be installed on the system base board and NX-4TRK option card (maximum of four per card) for detecting metering pulses. Optionally, MPD Hybrid ICs for 50Hz, 12kHz or 16kHz can be provided.
  
- iü **MDF** Samsung Electronics Co. can provide several types if user order. **NX-828** has room enough to accommodate MDF's in the cabinet if user install the MDF's provided by Samsung Electronics Co.

### 3.3 Station Equipments

- iü **Keypad with 24 buttons (NX-24E, NX-24B)**
  - Built-in speakerphone
  - 24 programmable soft keys (12 with tri-colored LEDs) and 10 fixed function keys
  - UP/DOWN buttons for digital control of speaker, handset and ringer volumes.
  - Four selective ring tones per keypad
  - Desk-mounted or wall-mounted
  - Can be connected to the SKP-308H/816H system
  - NX-24E keypad has a 1-line 16-character display.
  
- iü **Basic keypad with 6 buttons (NX-6B)**
  - 6 programmable soft keys and 10 fixed function keys
  - UP/DOWN buttons for digital control of speaker, handset and ringer volumes.
  - Four selective ring tones per keypad
  - Desk-mounted or wall-mounted
  - can be connected to **SKP-308H** system

Keypads come in one colour: Dark Grey.

- iü **Add-On Module (NX-AOM)**
  - 24 programmable soft keys
  
- iü **Door phone set (DPH)**
  - Can be connected to NX-DPH/PAGING card and uses a one (1) pair modular cable.

# 4. Specifications

## 4.1 Electrical Specifications

AC INPUT	230 VAC, 50 Hz
POWER CONSUMPTION	55 Watts maximum
MAX CURRENT DRAW AT 230 VAC	0.29 AMP
RING GENERATOR	AC 80 VRMS, 25 Hz
BATTERY BACKUP SUPPLY	24 VDC Batteries rating not less than 6 AH but not more than 26 AH

## 4.2 Dimensions and Weights

KEY SERVICE UNIT	530 mm H i¿ 412 mm W i¿ 140 mm , 8.9 kg
KEYSET	214 mm H i¿ 206 mm W i¿ 150 mm , 1.1 kg
AOM	214 mm H i¿ 133 mm W i¿ 150 mm , 0.4 kg
DOOR PHONE	158 mm H i¿ 89 mm W i¿ 41 mm , 0.23 kg









## 4.3 Environmental Limitations

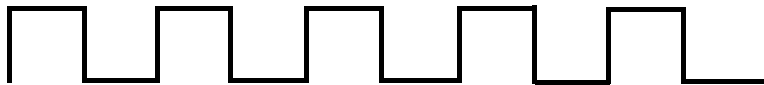

OPERATING TEMPERATURES	0 iÉ - 45 iÉ (18 iÉ - 25 iÉ recommended)
OPERATING HUMIDITY	10 % - 90 % (without condensation)
OPERATING INPUT VOLTAGE	230 VAC(20%), 48~62Hz

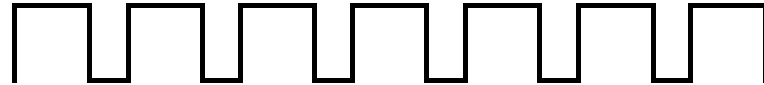
## 4.4 Cable Requirements

ELECTRONIC SET	2 pair twisted, 400 m 24 AWG maximum
SINGLE LINE TELEPHONE	1 pair twisted, 1 km 24 AWG maximum
DOOR PHONE	1 pair twisted, 100 m 24 AWG maximum

## 4.5 SYSTEM TONES AND RINGS

<b>DIAL TONE</b>	: A steady tone that indicates you can begin dialing.		CONTINUOUS
<b>RING BACK TONE</b>	: Indicates the station you dialed is ringing.		1000 ON / 2000 OFF / 1000 ON / 2000 OFF
<b>BUSY TONE</b>	: Indicates the station you dialed is busy.		500 ON / 500 OFF / 500 ON / 500 OFF
<b>TRANSFER TONE</b>	: Indicates your call is being held and you can dial another party.		200 ON / 200 OFF / 200 ON / 200 OFF
<b>ERROR TONE</b>	: Indicates you have done something incorrectly.		500 ON / 250 OFF / 500 ON / 250 OFF
<b>CONFIRMATION TONE</b>	: Indicates you have correctly set or canceled the system features.		100 ON / 100 OFF / 100 ON / 100 OFF
<b>INTRUSION TONE</b>	: Indicates you are barged.		200 ON / 200 OFF / 200 ON / 5000 OFF
<b>MESSAGE WAITING TONE</b>	: In case of SLT, indicates you have messages left.		200 ON / 200 OFF / 200 ON / 200 OFF

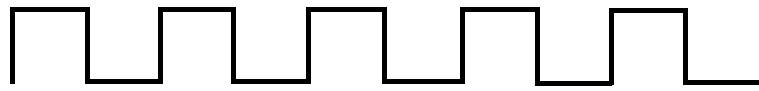
<b>CO LINE RING</b>	: Indicates a outside call is ringing on your station.
	1000 ON / 3000 OFF / 1000 ON / 3000 OFF
<b>STATION RING</b>	: Indicates an intercom call is ringing on your station.
	400 ON / 200 OFF / 400 ON / 3000 OFF
<b>DOORPHONE RING</b>	: Indicates a door phone call is ringing on your station.
	500 ON / 500 OFF / 500 ON / 500 OFF
<b>ALARM RING</b>	: Indicates an alarm ring is ringing on your station.
	500 ON / 500 OFF / 500 ON / 500 OFF

## 4.6 Keypad LED Indications

CONDITION	LED COLOR	LED STATUS
LINE IDLE	OFF	OFF
LINE IN USE	RED/GREEN	STEADY ON
RECALL	AMBER	FAST FLICKER
CALL ON HOLD	RED/GREEN	SLOW FLICKER
RINGING C.O. CALL	GREEN	FAST FLICKER
RINGING INTERNAL CALL	RED	FAST FLICKER
DND INDICATION	RED	STEADY ON



# INSTALLATION

# TABLE OF CONTENTS

# INSTALLATION

<b>1.</b>	<b>Site Requirements.....</b>	<b>2 - 1</b>
<b>2.</b>	<b>Installation Of Basic Ksu.....</b>	<b>2 - 1</b>
	2.1 Unpacking Basic KSU.....	2 - 1
	2.2 Mounting the KSU.....	2 - 1
	2.3 Grounding the KSU.....	2 - 2
	2.4 MDF Cabling.....	2 - 3
<b>3.</b>	<b>Installation Option Cards.....</b>	<b>2 - 11</b>
	3.1 3.1 NX-4TRK.....	2 - 11
	3.2 3.2 NX-4ODX.....	2 - 11
	3.3 3.3 NX-8KLI.....	2 - 11
	3.4 3.4 NX-8SLI.....	2 - 11
	3.5 3.5 NX-SMDR/R-MMC.....	2 - 11
	3.6 3.6 MPD Hybrid IC.....	2 - 11
	3.7 3.7 NX-DPH/PAGING.....	2 - 11
	3.8 Installing Expansion Cards on Base Board.....	2 - 14
<b>4.</b>	<b>Connecting Telephone Lines.....</b>	<b>2 - 15</b>
	4.1 Safety Precaution.....	2 - 15
	4.2 Loop Start Lines.....	2 - 15
<b>5.</b>	<b>Connecting Station Equipment.....</b>	<b>2 - 15</b>
	5.1 Connecting Keypad/AOM.....	2 - 15
	5.2 Connecting Single Line Telephone.....	2 - 16
<b>6.</b>	<b>Connecting Optional Equipment.....</b>	<b>2 - 17</b>
	6-1 External Music Source.....	2 - 17
	6-2 Door Phone and Door Lock Release.....	2 - 18
	6-3 External Paging.....	2 - 20
	6-4 SMDR / Remote Programming.....	2 - 20
	6-5 Power Failure Transfer.....	2 - 23
	6-6 External Battery .....	2 - 23
<b>7.</b>	<b>Before Power Up.....</b>	<b>2 - 24</b>

# 1. Site Requirements

When planning the installation of the **NX-828** system, choose a site that meets the following requirements:

- Select a location for the Key Service Unit (KSU) that has enough room for installation and has adequate lighting.
- Select a location that minimises cable lengths. Maximum cable length is 400 meters using AWG #24 cable for a keyset and 1 km using AWG #24 cable for a single line telephone.
- The equipment should not be exposed to direct sunlight, corrosive fumes, dust, constant vibration or strong magnetic fields such as those generated by motors and copying machines.
- A direct commercial AC power outlet is required. Do not use extension cords. Preferably, a dedicated circuit should be used to minimise the risk of other electrical equipment being connected that could adversely affect system operation. Ensure that all wires and cables going to and coming from the KSU are properly routed. Do not cross fluorescent lights or run parallel with AC wires.
- The equipment must be located in an environment that will maintain a temperature range of 0 - 40°C and a humidity range of 10% - 90% non-condensing.
- Do not install in close proximity to a fire sprinkler head or other sources of water.
- Do not install within a 2-mile radius of a broadcasting antenna.

## 2. Installation Basic KSU

### 2.1 Unpacking basic KSU

After unpacking the KSU, inspect for signs of physical damage. If any damage is detected, do not attempt to install.

Check to see that the KSU carton includes the following items:

- Key Service Unit
- Wall-mount bracket and three (3) screws
- Power cord

### 2.2 Mounting the KSU

The KSU must be wall-mounted using the bracket supplied (Figure 2-1). The KSU should be mounted on a plywood backboard at least 1.5 mm thick. Attach the bracket to backboard with the two screws supplied. Next, hang the KSU on the mounting bracket

## 2.3 Grounding the KSU

**WARNING:** Unplug the power cord from the AC supply before attempting to connect the ground. Hazardous voltage may cause death or injury. Observe extreme caution when working with AC power.

The NX-828 system comes equipped ready to use with a third wire AC ground provided through the power cord (Figure 2-2).

The grounding lug on the bottom of the KSU must be connected to a ground rod or metal cold water pipe using 10 AWG solid copper wire.

**CAUTION:** Failure to provide an adequate ground may cause problems or even circuit board failure.

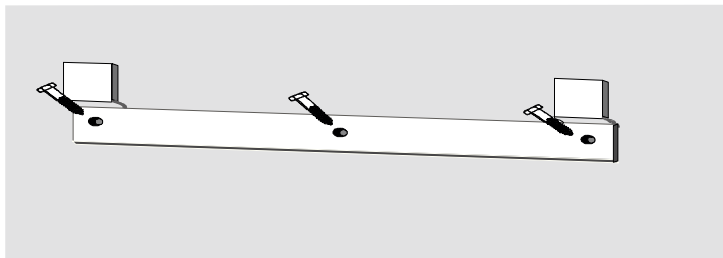

1. Fix the 3 screws into the wall
2. Hang the KSU on the wall-mount bracket

**Figure 2-1 Mounting the KSU**

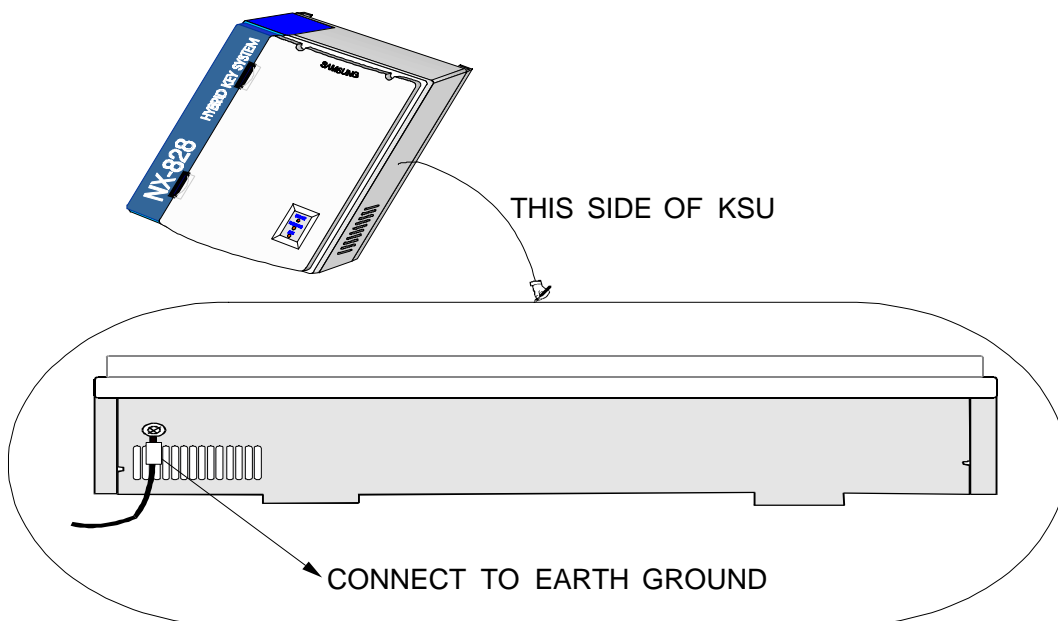

**Figure 2-2 Grounding the KSU**

## 2.4 MDF Cabling

All connections to the **NX-828** system are made by way of the main distribution frame (MDF) provided by SAMSUNG. The MDF connection can be done by using a 25 pair female amphenol-type cable. There are five(5) kinds of MDF(MDFB-CEU, MDFB-MEU, MDFD-C, MDFD-M4TRK and MDFD-M) for NX system and **Optional** MDF can be used with the **NX-828** system. MDFB-CEU and MDFB-MEU are for the basic KSU and the MDFD-C, MDFD-M and MDFD-M4TRK are used to connect the expansion B'd.

### iü **MDFB (Option B'd)**

Used to connect the **NX-828** basic KSU.

There are two types of MDFB ;

c¹ MDFB-CEU ( See **FIGURE 2£-3** )

c¹ MDFB-MEU ( See **FIGURE 2£-4** )

### iü **MDFD (Option B'd)**

Used to connect the expansion cards :

NX-4TRK, NX-4OPX, NX-8KLI, NX-8SLI

There are three types of MDFD ;

c¹ MDFD-C ( See **FIGURE 2£-5A , 2£-5B** )

c¹ MDFD-M4TRK ( See **FIGURE 2£-6** )

c¹ MDFD-M (See **FIGURE 2£-7** )

### iü **Optional MDF ( See FIGURE 2-8 )**

The MDF provided by SAMSUNG ELECTRONICS is configured as FIGURE 2-8.

It is composed of sixty (60) pair clips of which "IN" and "OUT" terminal is short internally.

The wire from the **NX-828** system champ connector is connected to the clip terminal marked "IN" and the wire to C.O, station, or the additional feature equipment can be connected from the clip terminal marked "OUT".

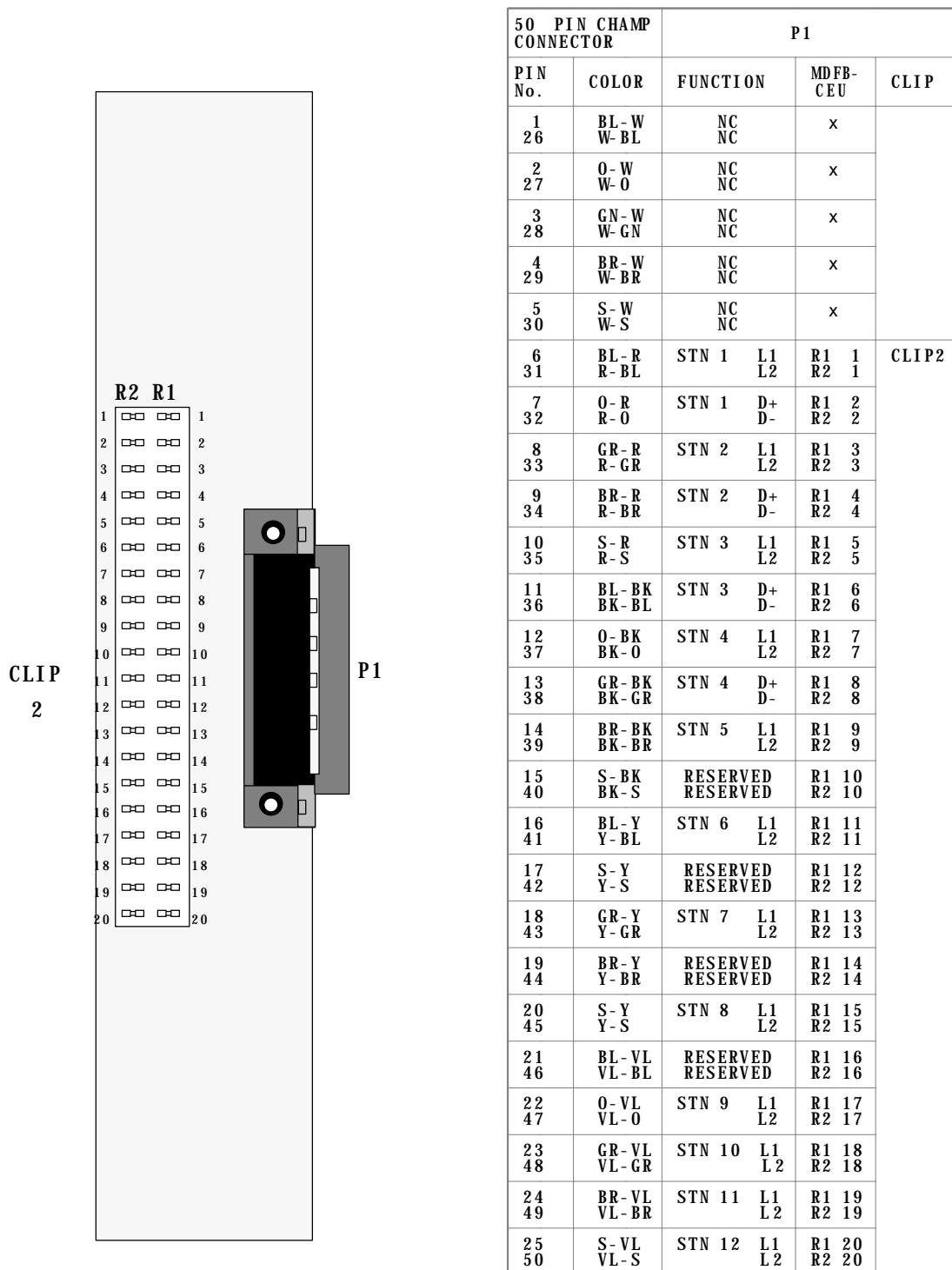

Figure 2-3 MDFB-CEU Connection

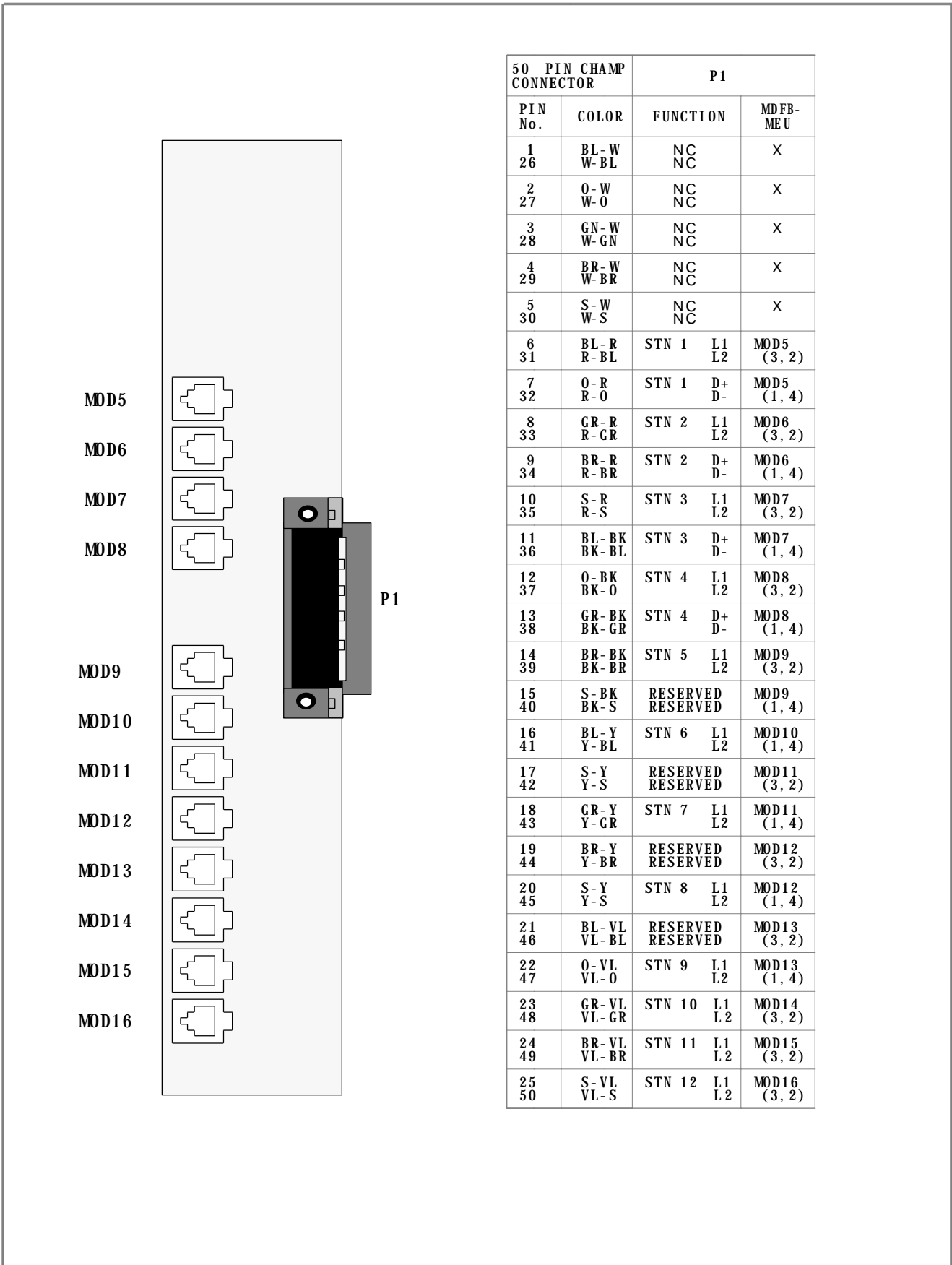

Figure 2-4 MDFB-MEU Connection

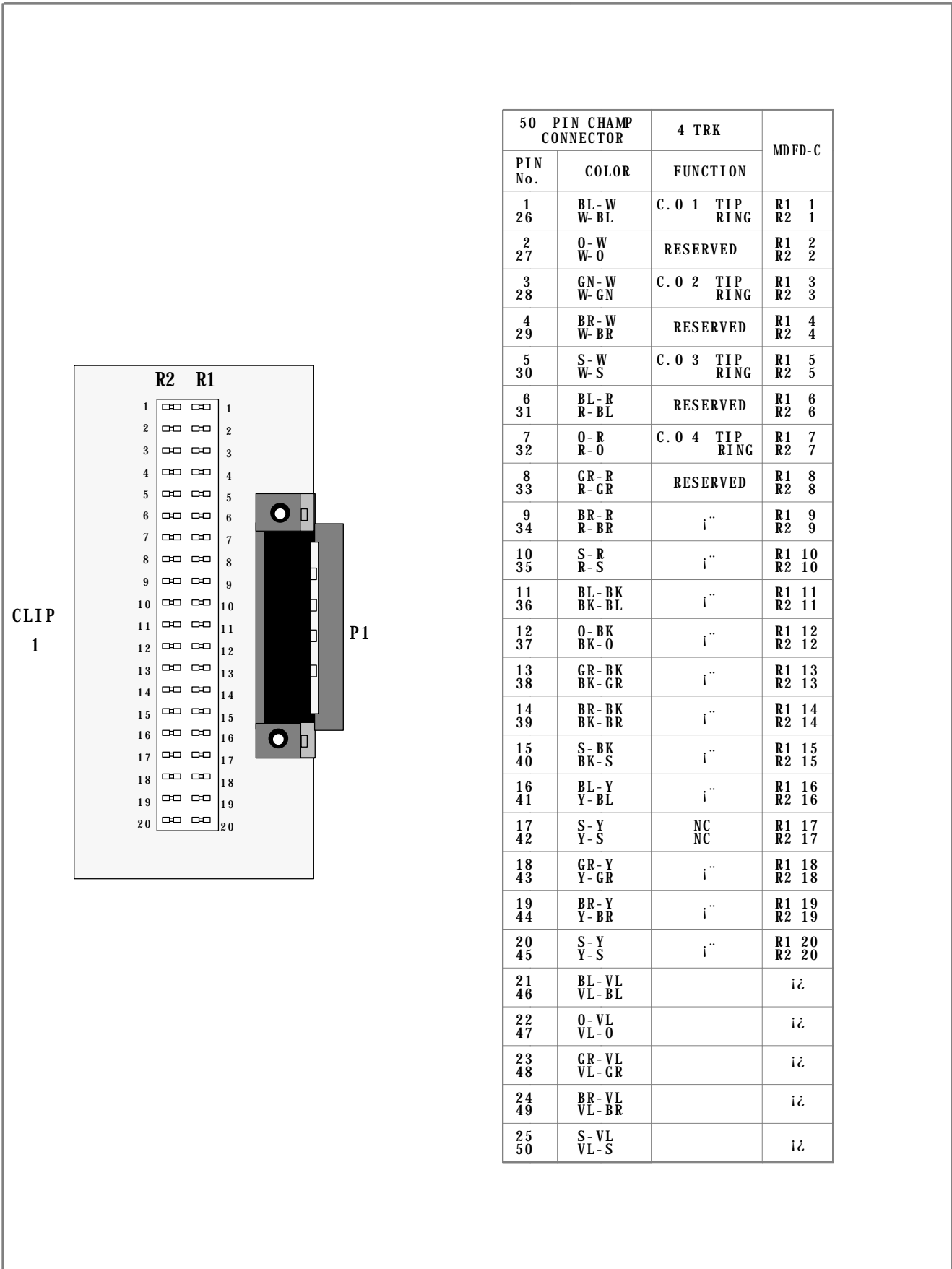
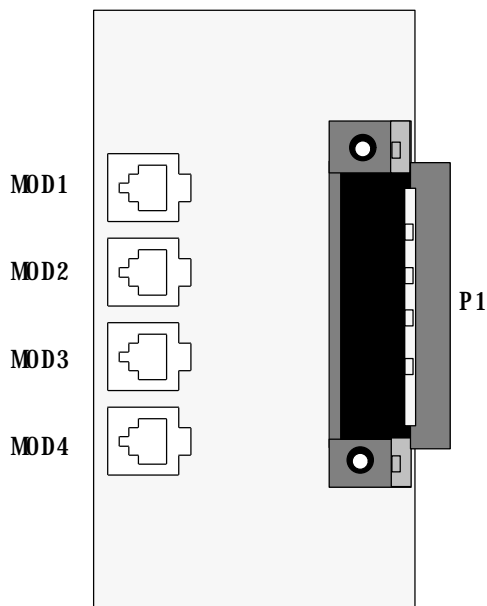

Figure 2-5A MDFD-C Connection

50 PIN CHAMP CONNECTOR		8 KLI	8 SLI	4 OPX	MDFD-C
PIN No.	COLOR	FUNCTION	FUNCTION	FUNCTION	
1 26	BL-W W-BL	STN 1 L1 L2	STN 1 L1 L2	STN 1 L1 L2	R1 1 R2 1
2 27	O-W W-O	STN 1 D+ D-	RESERVED	RESERVED	R1 2 R2 2
3 28	GN-W W-GN	STN 2 L1 L2	STN 2 L1 L2	STN 2 L1 L2	R1 3 R2 3
4 29	BR-W W-BR	STN 2 D+ D-	RESERVED	RESERVED	R1 4 R2 4
5 30	S-W W-S	STN 3 L1 L2	STN 3 L1 L2	STN 3 L1 L2	R1 5 R2 5
6 31	BL-R R-BL	STN 3 D+ D-	RESERVED	RESERVED	R1 6 R2 6
7 32	O-R R-O	STN 4 L1 L2	STN 4 L1 L2	STN 4 L1 L2	R1 7 R2 7
8 33	GR-R R-GR	STN 4 D+ D-	RESERVED	RESERVED	R1 8 R2 8
9 34	BR-R R-BR	STN 5 L1 L2	STN 5 L1 L2	i"	R1 9 R2 9
10 35	S-R R-S	STN 5 D+ D-	RESERVED	i"	R1 10 R2 10
11 36	BL-BK BK-BL	STN 6 L1 L2	STN 6 L1 L2	i"	R1 11 R2 11
12 37	O-BK BK-O	STN 6 D+ D-	RESERVED	i"	R1 12 R2 12
13 38	GR-BK BK-GR	STN 7 L1 L2	STN 7 L1 L2	i"	R1 13 R2 13
14 39	BR-BK BK-BR	STN 7 D+ D-	RESERVED	i"	R1 14 R2 14
15 40	S-BK BK-S	STN 8 L1 L2	STN 8 L1 L2	i"	R1 15 R2 15
16 41	BL-Y Y-BL	STN 8 D+ D-	RESERVED	i"	R1 16 R2 16
17 42	S-Y Y-S	NC NC	NC NC	NC NC	R1 17 R2 17
18 43	GR-Y Y-GR	i"	i"	i"	R1 18 R2 18
19 44	BR-Y Y-BR	i"	i"	i"	R1 19 R2 19
20 45	S-Y Y-S	i"	i"	i"	R1 20 R2 20
21 46	BL-VL VL-BL				i¿
22 47	O-VL VL-O				i¿
23 48	GR-VL VL-GR				i¿
24 49	BR-VL VL-BR				i¿
25 50	S-VL VL-S				i¿

**Figure 2-5B MDFD-C Connection**



50 PIN CHAMP CONNECTOR		4 TRK	MDFD-M4TRK
PIN No.	COLOR	FUNCTION	
1 26	BL-W W-BL	C. 0 1 TIP RING	MOD1 (4, 1)
2 27	O-W W-O	RESERVED	i
3 28	GN-W W-GN	C. 0 2 TIP RING	MOD2 (4, 1)
4 29	BR-W W-BR	RESERVED	i
5 30	S-W W-S	C. 0 3 TIP RING	MOD3 (4, 1)
6 31	BL-R R-BL	RESERVED	i
7 32	O-R R-O	C. 0 4 TIP RING	MOD4 (4, 1)
8 33	GR-R R-GR	RESERVED	i
9 34	BR-R R-BR	i	i
10 35	S-R R-S	i	i
11 36	BL-BK BK-BL	i	i
12 37	O-BK BK-O	i	i
13 38	GR-BK BK-GR	i	i
14 39	BR-BK BK-BR	i	i
15 40	S-BK BK-S	i	i
16 41	BL-Y Y-BL	i	i
17 42	S-Y Y-S	NC NC	i
18 43	GR-Y Y-GR	i	i
19 44	BR-Y Y-BR	i	i
20 45	S-Y Y-S	i	i
21 46	BL-VL VL-BL		i
22 47	O-VL VL-O		i
23 48	GR-VL VL-GR		i
24 49	BR-VL VL-BR		i
25 50	S-VL VL-S		i

Figure 2-6 MDFD-M4TRK Connection

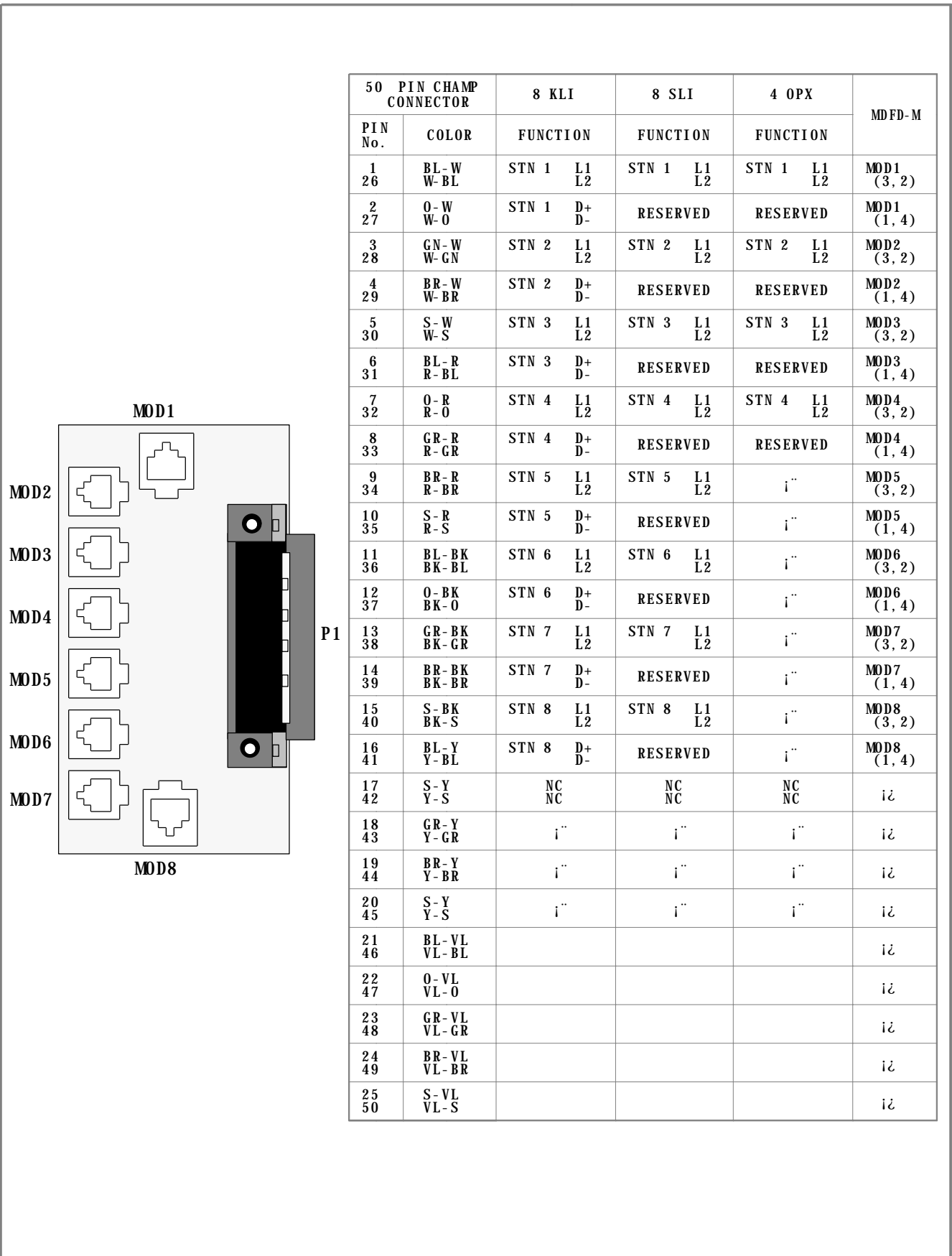
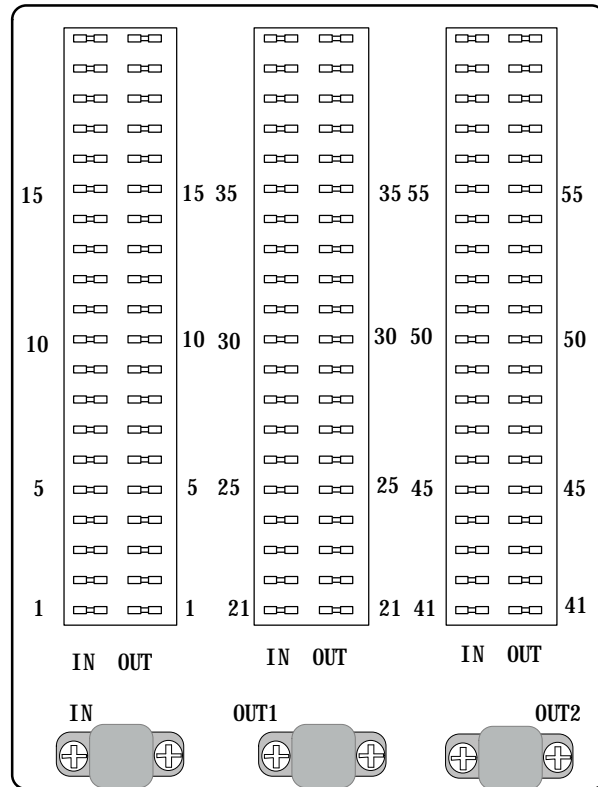

Figure 2-7 MFD-M Connection



MDF Pin No.	Champ Pin No.	MDF Pin No.	Champ Pin No.	MDF Pin No.	Champ Pin No.
1	26	21	36	41	46
2	1	22	11	42	21
3	27	23	37	43	47
4	2	24	12	44	22
5	28	25	38	45	48
6	3	26	13	46	23
7	29	27	39	47	49
8	4	28	14	48	24
9	30	29	40	49	50
10	5	30	15	50	25
11	31	31	41	51	reserved
12	6	32	16	52	reserved
13	32	33	42	53	reserved
14	7	34	17	54	reserved
15	33	35	43	55	reserved
16	8	36	18	56	reserved
17	34	37	44	57	reserved
18	9	38	19	58	reserved
19	35	39	45	59	reserved
20	10	40	20	60	reserved

**Figure 2-8 Optional MDF**

## 3. Installation Option Cards

Unpack and inspect each card before installing. Check for signs of physical damage. If any damage is detected, do not attempt to install.

### 3.1 NX-4TRK

Insert the NX-4TRK card (Figure 2-9) into any expansion slot. Push firmly to ensure that it is fully inserted into the back plane connector.

### 3.2 NX-4OPX

Insert the NX-4SLI (OPX) card (Figure 2-10) into any expansion slot. Push firmly to ensure that it is fully inserted into the back plane connector.

### 3.3 NX-8KLI

Insert the NX-8KLI card (Figure 2-11) into any expansion slot. Push firmly to ensure that it is fully inserted into the back plane connector.

### 3.4 NX-8SLI

Insert the NX-8SLI card (Figure 2-12) into any expansion slot. Push firmly to ensure that it is fully inserted into the back plane connector.

### 3.5 NX-SMDR/R-MMC

Install the NX-SMDR/R-MMC card (Figure 2-13) on the base board.

### 3.6 MPD Hybrid IC

Insert into IC socket for MPD Hybrid IC on the NX-4TRK option card and the base board (Figure 2-14).

### 3.7 NX-DPH/PAGING

Install the NX-DPH/PAGING card (Figure 2-15) on the base board.

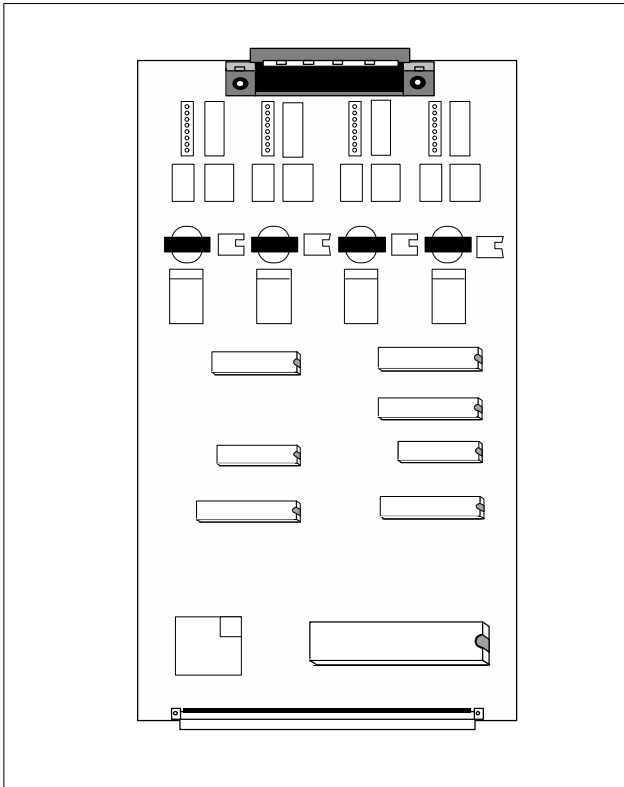

**Figure 2-9 4TRK Card**

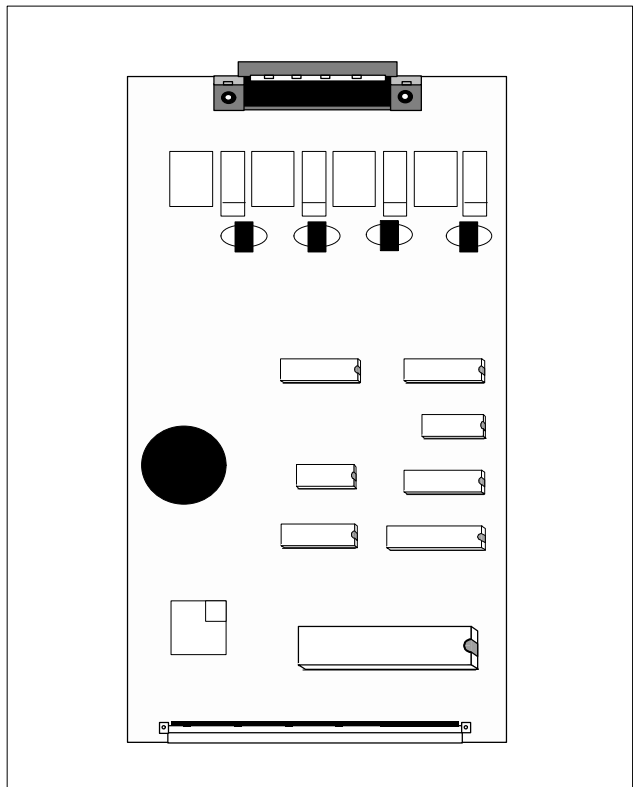

**Figure 2-10 4OPX Card**

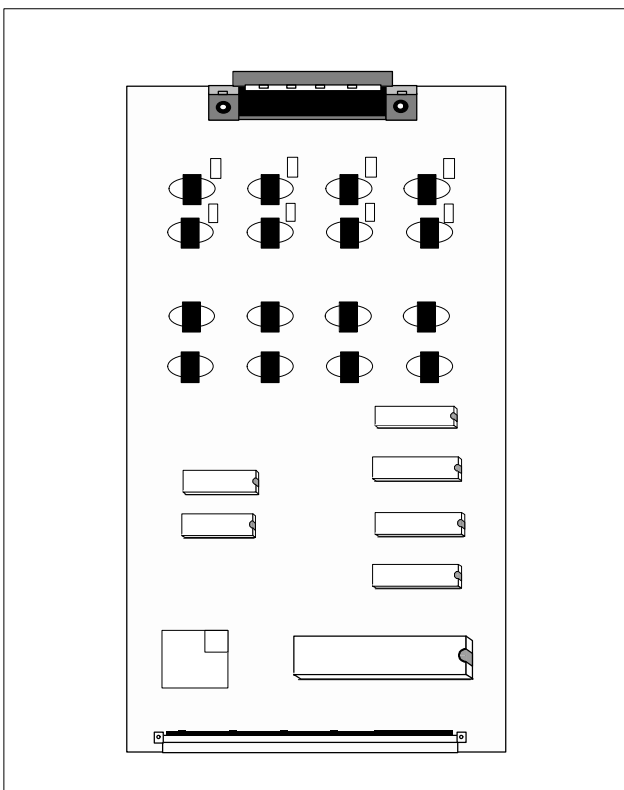

**Figure 2-11 8KLI Card**

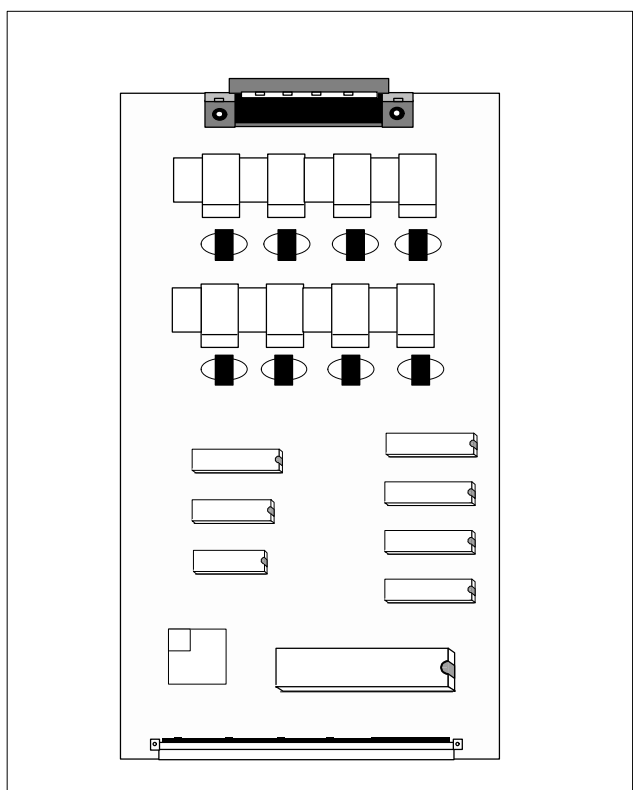

**Figure 2-12 8SLI Card**

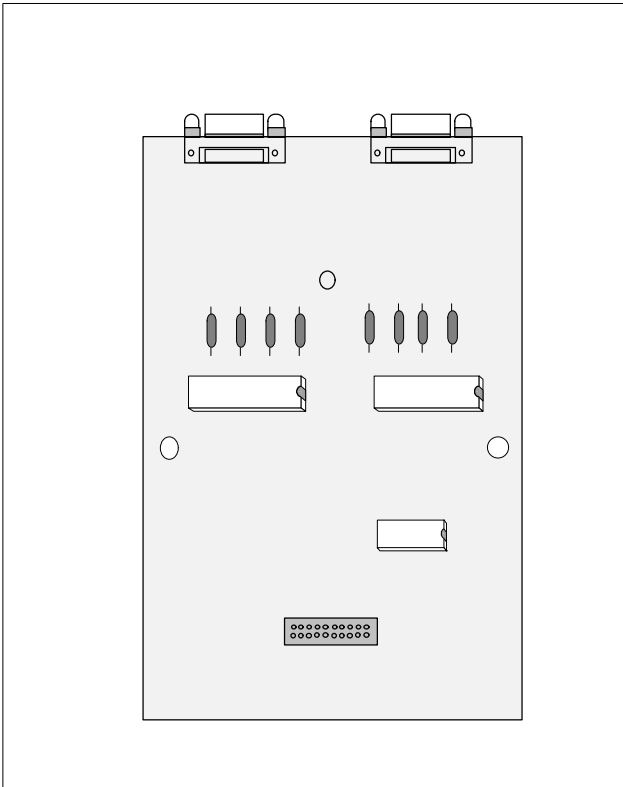

**Figure 2-13 SMDR/R-MMC Card**

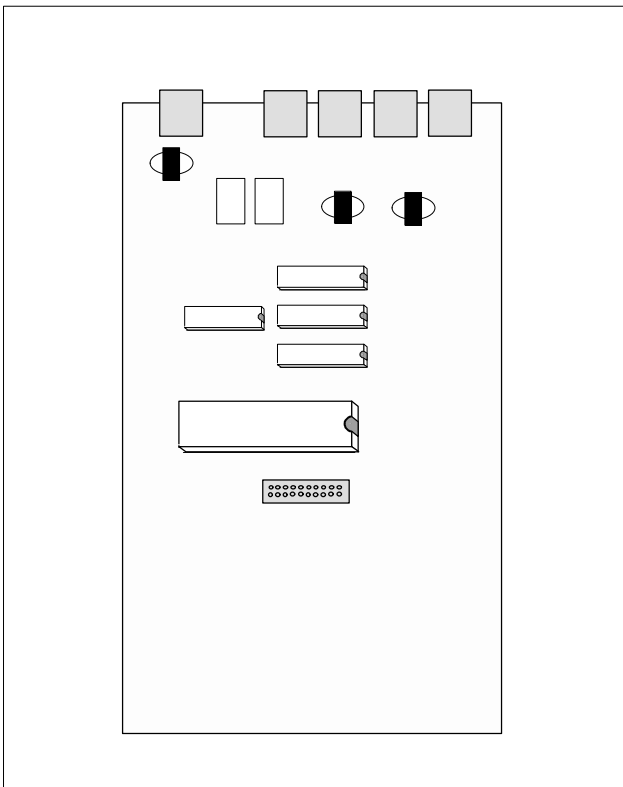

**Figure 2-15 DPH/PAGING Card**

For 12KHz

For 16KHz

For 50Hz

**NOTE:**

1. Check pin position of MPD Hybrid IC sockets on 4 TRK card and base board.
2. No contact point of pin 2.

**Figure 2-14 MPD Hybrid IC**

### 3.8 Installing Expansion Cards on Base Board

NX-828 can have up to three expansion cards under the base board. NX-SMDR/R-MMC, NX-DPH/PAGING and NX-MPD Hybrid ICs are installed on the surface of the base board (Figure 2-16).

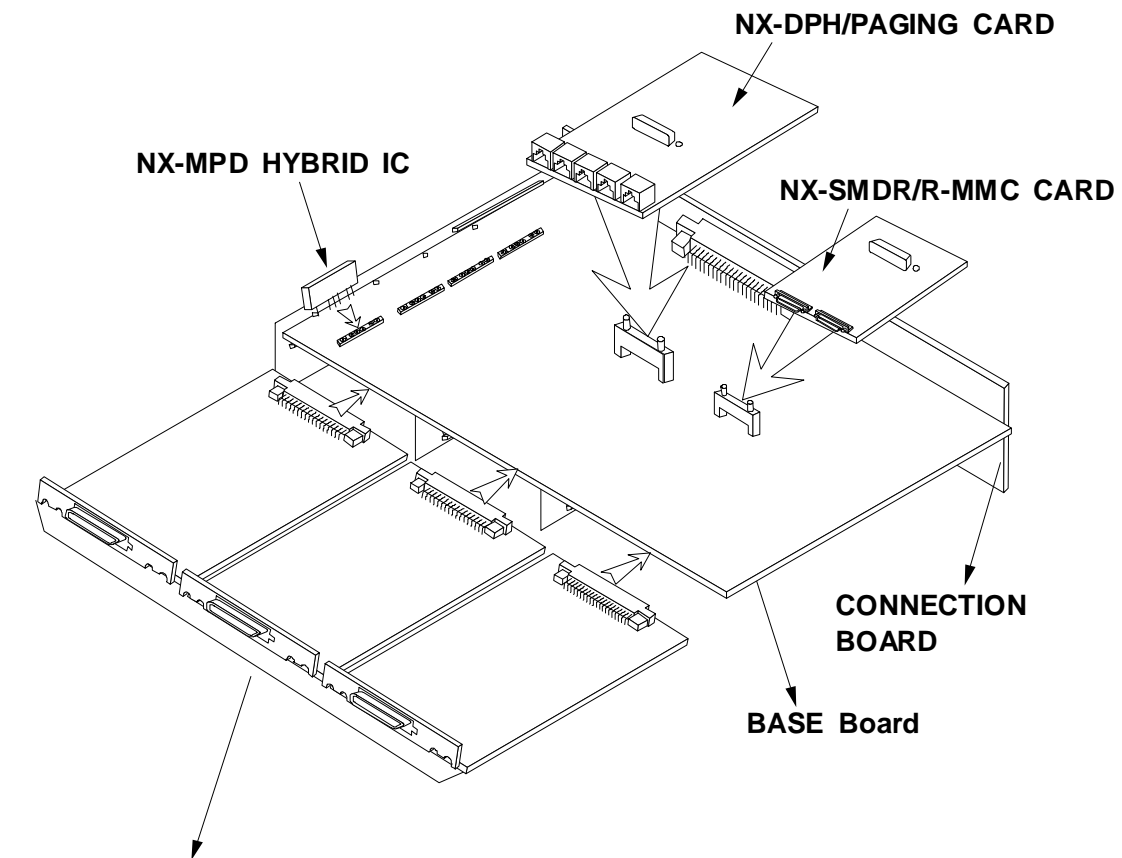

Three Expansion cards in any slot :  
 Push firmly to ensure cards fully inserted into  
 back plane connector on connection board

**Figure 2-16 Installing Expansion Cards**

## 4. Connecting Telephone Lines

### 4.1 Safety Precautions

To limit the risk of personal injury, always follow these precautions before connecting PSTN circuits:

- ⓘ Never install telephone wiring during a lightning storm.
- ⓘ Never install telephone jacks in a wet location unless the jack is specifically designed for wet locations.
- ⓘ Never touch uninsulated telephone wires or terminals unless the telephone line has been disconnected at the network interface.
- ⓘ Use caution when installing or modifying telephone lines.

### 4.2 Loop Start Lines

- ⓘ Using one pair twisted #24 AWG or #26 AWG jumper wire, cross-connect each loop start C.O. line to the trunk port.
- ⓘ Refer to FIGURE 2-5A and FIGURE 2-6.

## 5. Connecting Station Equipment

### 5.1 Connecting Keypad/ Aom

To connect the keypad or AOM to the any station from #1 to #4 of basic KSU, see Figure 2-17

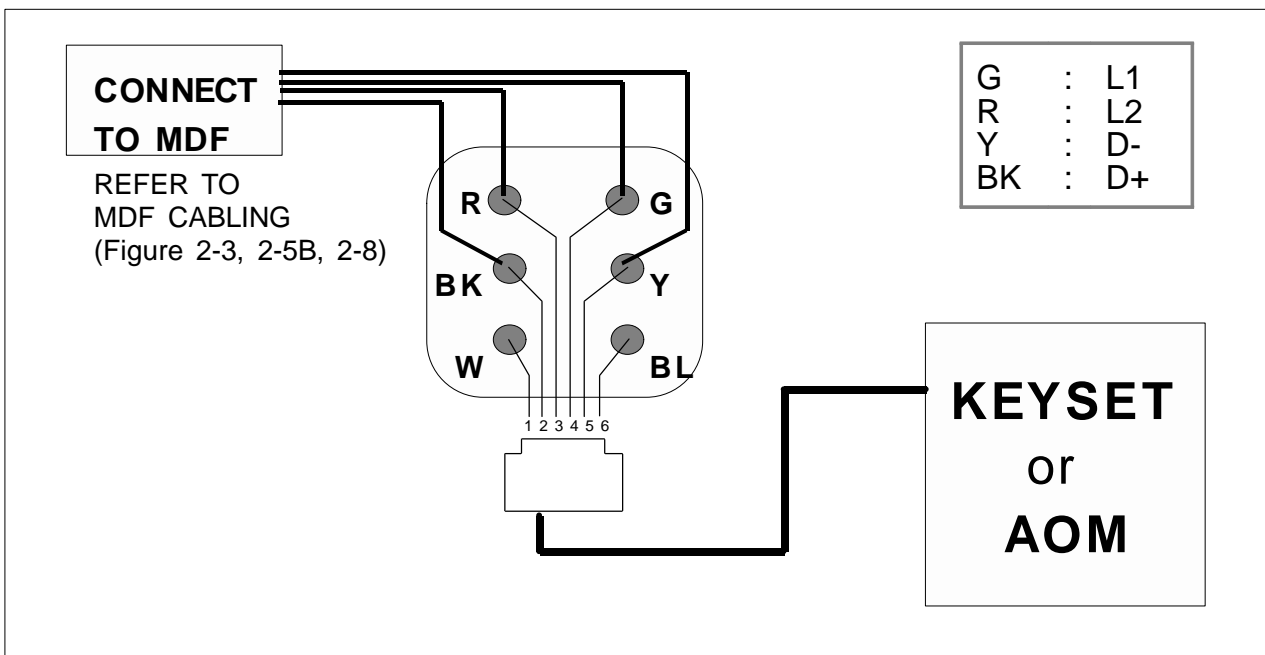

Figure 2-17 Connecting KEYSSET / AOM

## 5.2 Connecting Single Line Telephone

To connect the single line telephone to the any station from #5 to #12 of basic KSU, see Figure 2-18

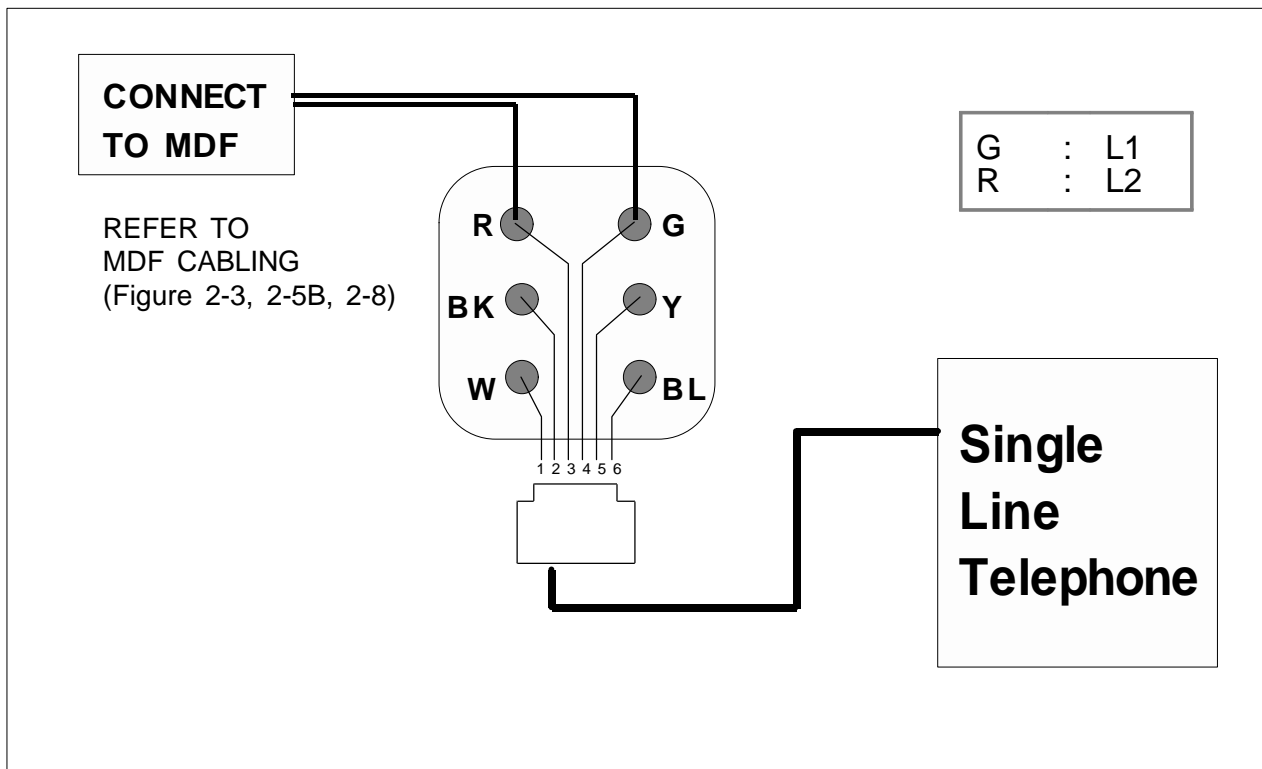

Figure 2-18 Connecting Single Line Telephone

## 6. Connecting Optional Equipment

### 6.1 External Music Source

The system is equipped with an internal melody IC chip to provide Music On Hold (MOH) through the keyset. However, when this is not desired, an external music source such as a radio or tape recorder can be connected to the system.

The external music source can be connected to the EXT.MUSIC jack on the KSU using a modular jack (Figure 2-19). After connecting the External Music Source, set the Music Source selection shunt pin to EXT (Figure 2-21).

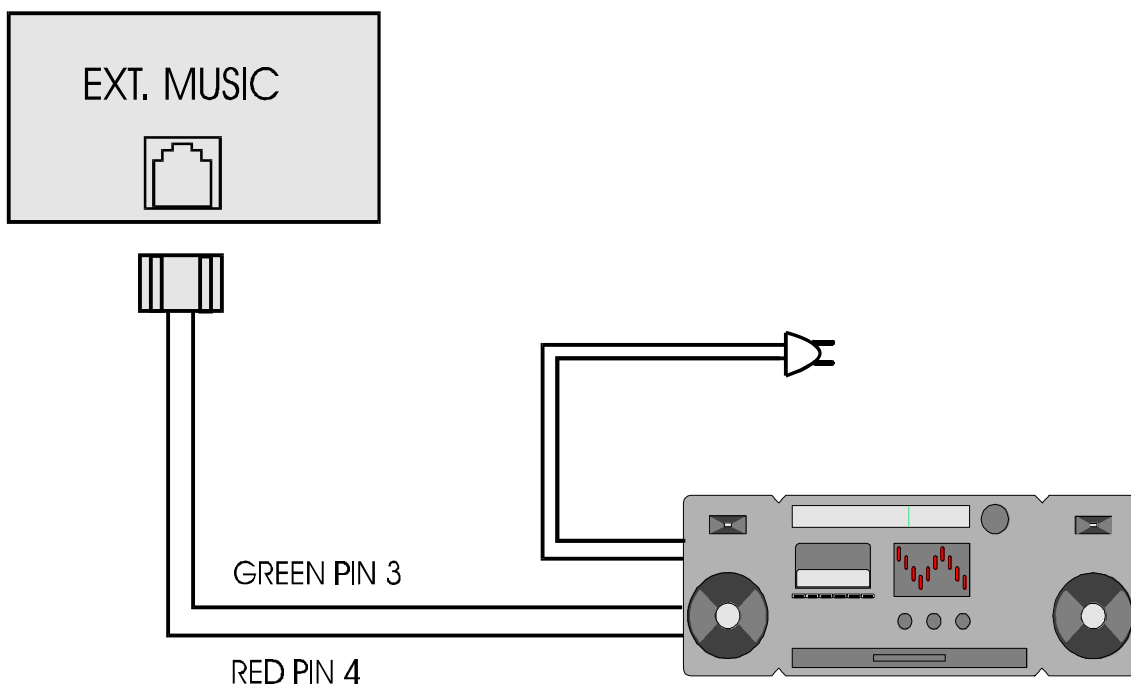

**Figure 2-19 Connecting External Music Source**

## 6.2 Door phone and Door Lock Release

System users can communicate with an optional door phone when the NX-DPH/PAGING card is installed. A maximum of two door phones may be installed per system. To connect the door phone, check the polarity and plug a two pair modular cable into the connector on the KSU marked DOOR1 or DOOR2 and connect the cable to the terminal of the door phone as shown in Figure 2-20.

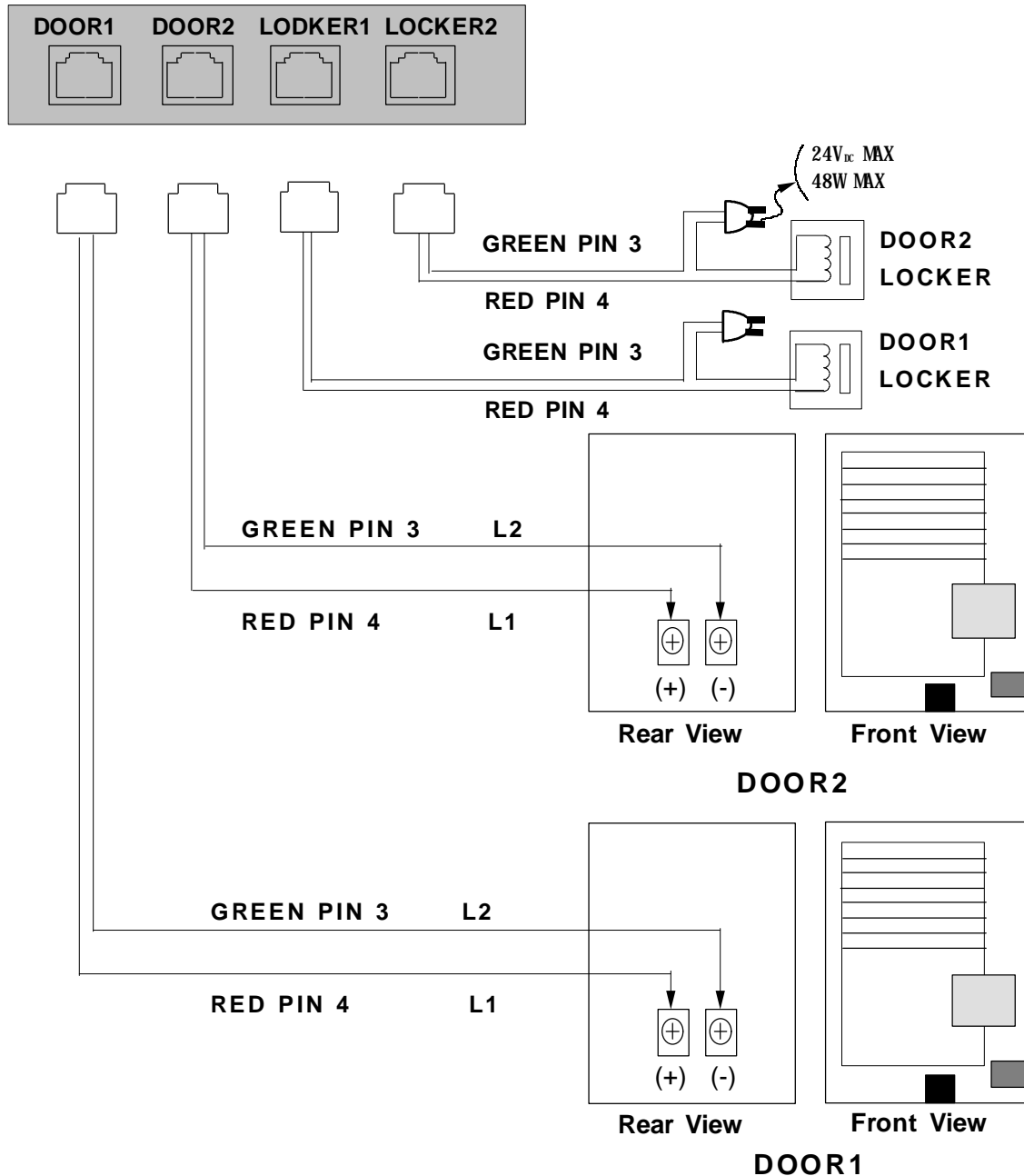

**Figure 2-20 Connecting Door Phone / Door Lock Release**

To connect the customer-provided electric door lock unit for control of the door lock release mechanism, plug a one pair modular cable into the connector on the KSU marked LOCKER1 or LOCKER2.

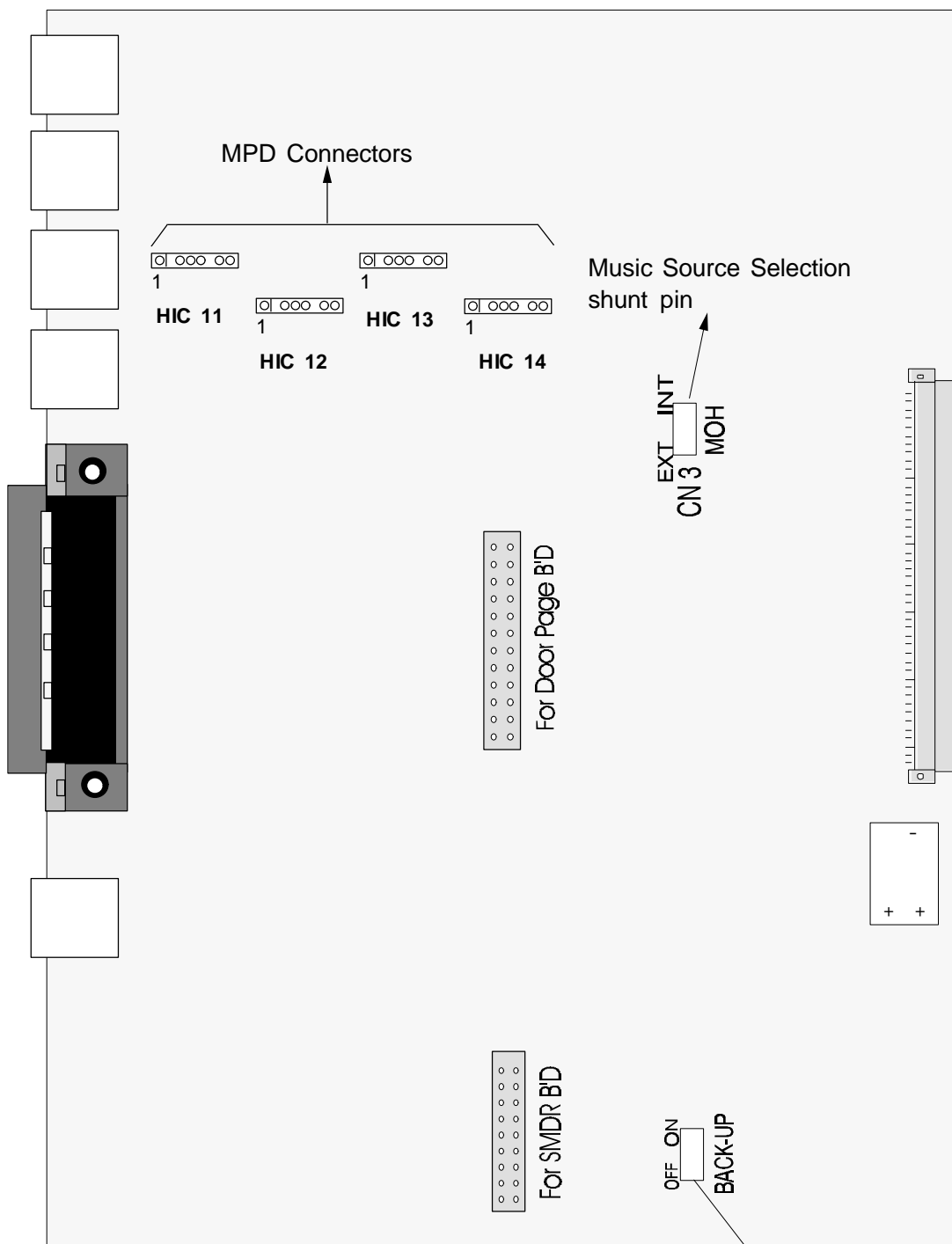

**Figure 2-21 KSU Switch Locations**

Memory  
Back-up  
enable  
shunt pin

### 6.3 External Paging

Customer-provided paging equipment can be connected to the PAGING jack using a modular jack when the NX-DPH/PAGING card is installed (Figure 2-22).

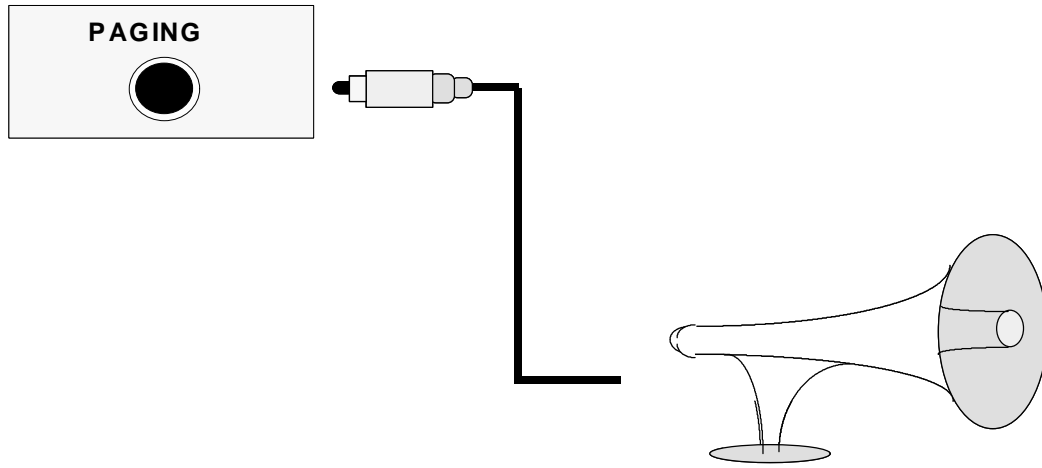

Figure 2-22 Connecting External Paging

### 6.4 SMDR / Remote Programming

For Station Message Detailed Recording (SMDR) or remote programming, the NX-SMDR/R-MMC card should be installed.

The NX-SMDR/R-MMC card provides two (2) serial I/O ports: R-MMC and SMDR. The port marked 'R-MMC' is used for remote programming and the port marked 'SMDR' is used for SMDR (Figure 2-23). Port parameters can be set using MMC 80 (see Programming section).

SMDR provides details of outside calls made through the system that can be sent to a customer-provided printer, data buffers or a CRT. Connect the cable for SMDR as shown below.

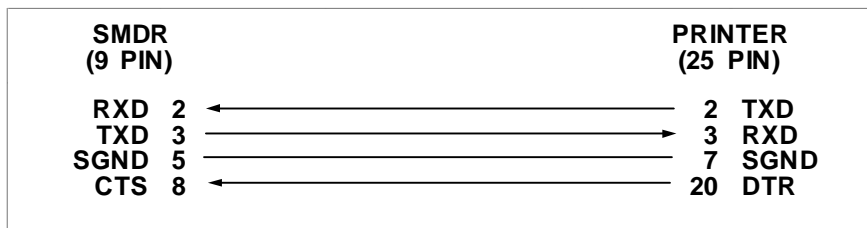

For remote programming, a customer-provided modem should be connected. Connect the cable for remote programming as shown below.

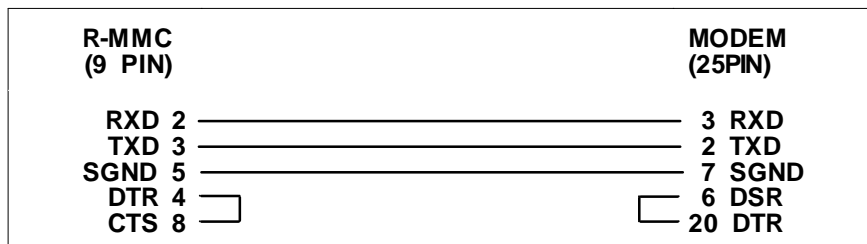

For on-site programming via a PC terminal, connect the cable as shown below.

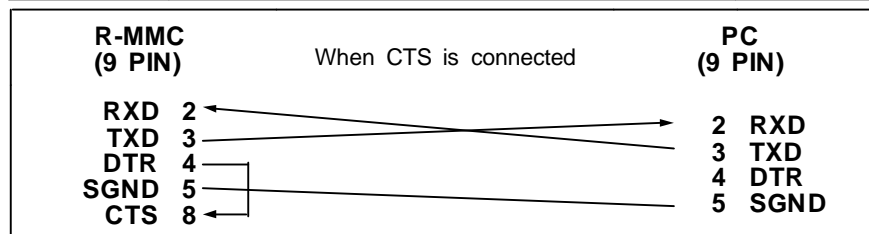
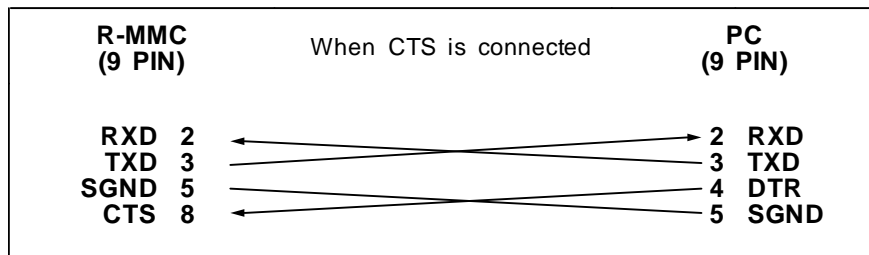
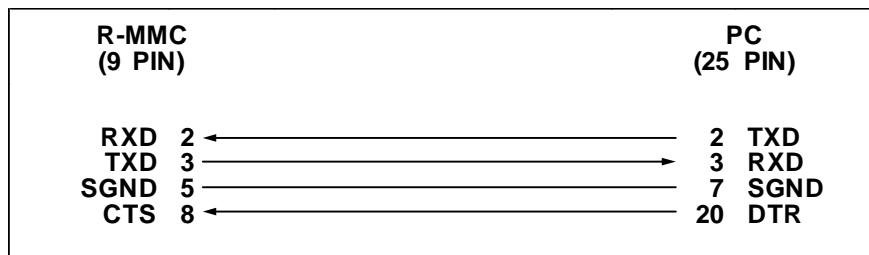

NOTE : If the CTS pin is not connected, the system cannot check the printer/modem status (power ON/OFF, paper empty, etc).

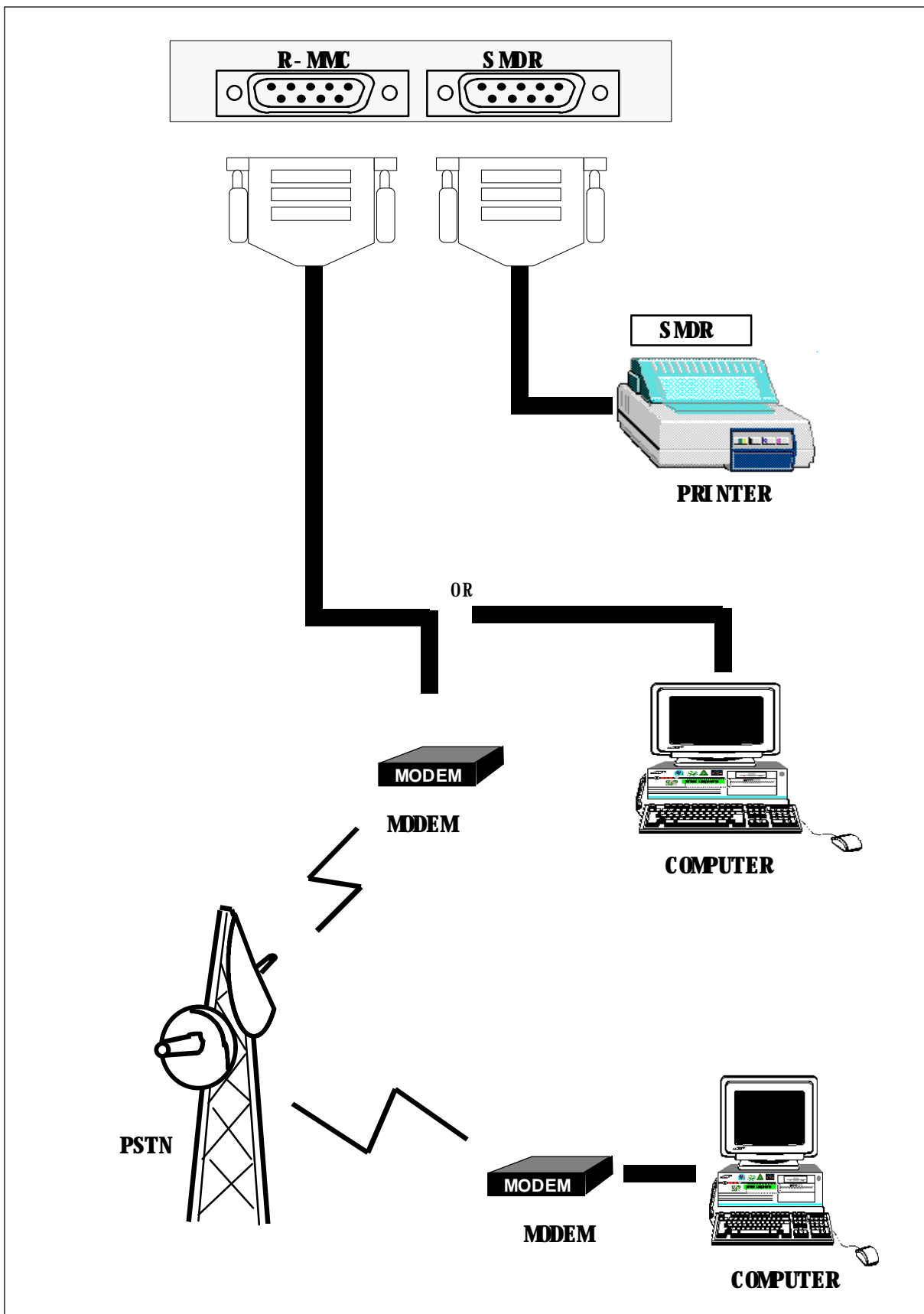

**Figure 2-23 Connecting For SMDR / Remote Programming**

## 6.5 Power Failure Transfer

When the system loses AC power, the first two loop start lines in the KSU are automatically switched to the related single line telephones.

The first and second trunk lines are respectively transferred to the 11th and 12th stations which are connected to the single line telephone.

## 6.6 External Battery

The system can continue full operation during AC power failure. This requires that a 24V battery supply be connected to the bottom of the KSU (Figure 2-24).

When AC power drops below 88V/176 VAC, the system switches over to batteries immediately. Calls in progress will not be interrupted.

To supply 24 volts, use two 12V batteries or four 6V batteries connected in series. Any Ni-Cd battery can be used if its rating is not more than 26AH and not less than 6AH. The system will not operate in power failure mode if battery voltage drops below 21.5 VDC.

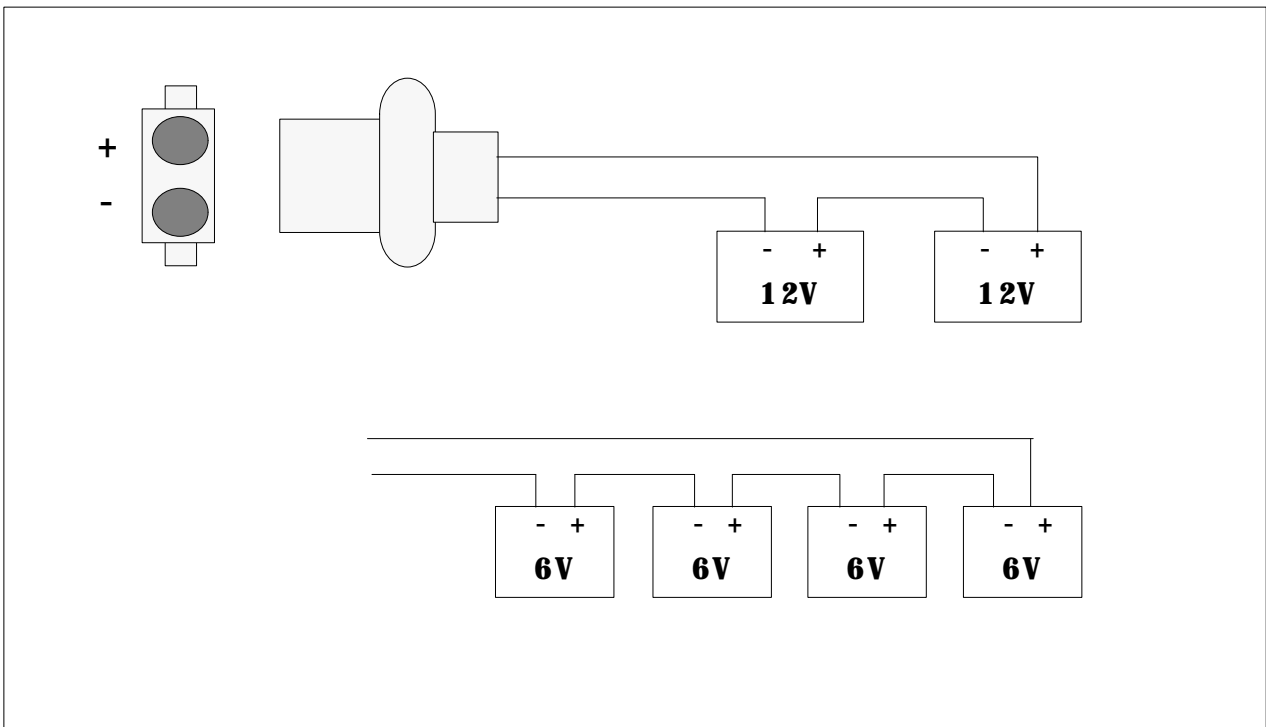

**Figure 2-24 Connecting External Batteries**

## 7. Before Power Up

During the initial installation, it is best to verify proper system operation before plugging in any amphenol-type cables to the MDF.

1. If you have already plugged the cables in, unplug them.
2. Verify that the AC voltage at the dedicated electric outlet is in a valid range.
3. Make sure the AC power switch is in the OFF position and the memory back-up switch is ON.
4. Plug the KSU power cord into the dedicated polarised AC outlet.
5. Turn the AC power switch to the ON position. Then verify the status of the 'POWER', 'MONITOR' and 'IDLE' LEDs on the cover of the KSU.

Steady lighting of the 'POWER' LED indicates the presence of power, and a blinking 'MONITOR' LED indicates that the main processor is functioning.

Steady lighting of the 'IDLE' LED indicates that the system is not in use.

**If the 'POWER' LED fails to light**, unplug the system, remove the power supply and check the AC fuse located on the bottom.

**If the fuse is good but the 'POWER' LED does not light**, you must correct the problem before continuing. To do this:

1. Turn off the power switch.
2. Unplug all expansion cards except the base board.
3. Turn the system on and check the 'POWER' LED again. If the problem is corrected, you have a defective card. Test and remove the faulty card before continuing.

If the LED still does not light, unplug the KSU and change the power supply or base board. This should solve the problem. If it does not, contact your dealer for advice.

# FEATURES

---

# TABLE OF CONTENTS

# FEATURES

<b>1.</b>	<b>Feature Description.....</b>	<b>3- 1</b>
	1.1 System Features.....	3- 1
	1.2 Station Features.....	3- 17
	1.3 Display Features.....	3- 24
<b>2.</b>	<b>Feature ID Table.....</b>	<b>3- 27</b>

# 1. Feature Description

## 1.1 System Features

- ACCOUNT CODE (Voluntary)
- ALL CALL VOICE PAGE
- ATTENTION TONE
- AUTHORIZATION CODES (Voluntary)
- AUTOMATIC HOLD
- BACKGROUND MUSIC
- BATTERY BACKUP (Memory Protection)
- BATTERY BACKUP (System)
- CALL FORWARDING
  - FORWARD ALL
  - FORWARD BUSY
  - FORWARD NO ANSWER
  - EXTERNAL CALL FORWARD
- CALL HOLD
- CALL HUNT
- CALL METERING
- CALL PICKUP
- CALL WAITING/CAMP-ON
- CENTREX/PBX USE
- CHAIN DIALLING
- CLASS OF SERVICE
- CONFERENCE
- DATABASE PRINTOUT
- DATA SECURITY
- DIRECT IN LINES
- DIRECT INWARD SYSTEM ACCESS (DISA)
- DISA VOICE ANNOUNCEMENT
- DIRECT TRUNK SELECTION
- DIRECTORY NAMES
- DISTINCTIVE RINGING
- DOOR LOCK RELEASE (Programmable)
- DOOR PHONES OPERATION
- DOOR PHONE DAY/NIGHT RING
- EMERGENCY CALL
- EXTERNAL MUSIC INTERFACE
- EXTERNAL PAGE INTERFACE
- FLASH KEY OPERATION
- FLEXIBLE NUMBERING
- FLEXIBLE RINGING
- HOT/WARM LINE
- IN GROUP/OUT OF GROUP
- INCOMING CALL DISTRIBUTION
- INCOMING / OUTGOING SERVICE
- INDIVIDUAL LINE CONTROL
- LIVE SYSTEM PROGRAMMING
  - TECHNICIAN LEVEL
  - CUSTOMER LEVEL
  - STATION LEVEL
- MEET ME PAGE AND ANSWER
- MESSAGE WAITING INDICATION
- MICROPHONE ON/OFF PER STATION
- NIGHT SERVICE
  - MANUAL NIGHT SERVICE
  - AUTOMATIC NIGHT SERVICE
- OFF PREMISES EXTENSION (OPX)
- OPERATOR GROUP
- OVERFLOW
- PAGING
- PAUSE DIAL
- PORT STATUS CHECK
- POWER FAILURE TRANSFER
- PRIME LINE SELECTION
- PRIVATE LINES
- PROGRAMMABLE LINE PRIVACY
- PROGRAMMABLE TIMERS
- RECALLS
- REMOTE PROGRAMMING(Option)
- RING OVER PAGE
- SINGLE LINE CONNECTIONS
- SPEED DIAL NUMBERS
  - STATION SPEED DIAL
  - SYSTEM SPEED DIAL
- STATION HUNT GROUPS
- STATION MESSAGE DETAIL RECORDING(SMDR)
- STATION TO STATION CALLING RESTRICTION
- SYSTEM DIRECTORY
- SYSTEM HALT
- TOLL RESTRICTION and OVERRIDE
  - SYSTEM SPEED DIAL TOLL RESTRICTION OVERRIDE
  - AUTHORIZATION CODE
  - WALKING CLASS OF SERVICE
  - URGENT CODE
- TONE OR PULSE DIALLING
- TRAFFIC REPORT PRINTOUT
- TRANSFER
- TRUNK DISCONNECT SIGNAL
- TRUNK GROUPS
- UNIVERSAL NIGHT ANSWER (UNA)

## Account Code (Voluntary)

Station users may enter an account code (maximum seven (7) digits) before hanging up from a call. This account code will appear in relevant column of the SMDR printout for that call record. Keypad users may enter this code using an ACC button without interrupting a conversation. Single line set users must temporarily interrupt the call by hook-flashing (or pressing the FLASH key on a Samsung Single Line Telephone) and dialling the feature access code. (the default code is 47). If the system has an MPD card installed and uses the call metering feature, the COST will be printed in the cost column of the SMDR printout.

See: MMC 57 Call Cost  
MMC 70 Dial Numbering Plan (default code for ACC: 47)  
MMC 71 System Key Programming  
MMC 72 Station Key Programming

## All Call Voice Page

Users can page all keysets and the external paging zone at the same time. Keypads may be restricted from receiving pages in system programming.

See: MMC 22 Customer On/Off

## Attention Tone

To get your attention, a brief tone precedes all page announcements or intercom voice calls.

## Authorization Codes (Voluntary)

Authorisation codes are used to validate a station user and give permission to make a call. These 4-digit codes are voluntary. Authorisation codes will automatically adjust the dialling station's dialling class of service to the level assigned to the authorisation code. Certain phone numbers (such as emergency numbers) may be dialled even if the authorisation codes are not known. Authorisation table numbers may optionally print on the SMDR output.

See: MMC 63 Authorisation Code  
MMC 81 SMDR Option

## Automatic Hold

Station users can enable or disable automatic hold at their keysets. While engaged on an outside call, pressing another trunk key automatically puts the call on hold when this feature is enabled. Pressing the TRANSFER, CONFERENCE, PAGE or DSS key automatically puts calls on hold. This is not a user-selectable option.

See: MMC 12 Station On/Off (Default for AUTO HOLD: OFF)

## Background Music

Keypad users can choose to hear music through their speakers by pressing the HOLD button while on-hook. There are two types of music sources: internal and external. The music source is selected using the shunt pin on the base board (see Figure 2-15 in the Installation section).

See: MMC 22 Customer On/Off (Default for BGM: ON)

## Battery Backup (Memory Protection)

If power is lost to the system, all customer data contained in memory is backed up by a Ni/Cd battery for at least seven (7) days continuous loss of system power. When power is restored, the system will recharge the Ni/Cd battery.

## Battery Backup (System)

If a 24VDC battery source is connected, the system is fully operational when AC power is interrupted. When AC power is restored, the system recharges the batteries. Calls in progress are not interrupted when the system switches over.

## Call Forwarding

This feature allows the user to forward incoming calls. The calls can be redirected to the operator group, external number, another station or station group. If the destination is in Do Not Disturb (DND) mode, the calling party will receive DND tone. Calls cannot be forwarded to a door phone.

See: MMC 11 Call Forward  
MMC 70 Dial Numbering Plan  
MMC 71 System Key Programming  
MMC 72 Station Key Programming

### ***Forward All***

This type of forwarding is not affected by the condition of the station. All calls are immediately redirected to the designated destination.

### ***Forward Busy***

Forwards all calls only when the station is busy. The station user can originate calls as usual.

### ***Forward No Answer***

Forwards calls that are not answered within a preprogrammed time. The station user can originate calls as usual and receive calls if present. The timer is programmable on a per-station basis to allow for differences in individual work habits.

### **External Call Forward**

A keyset user can be given an External Call Forward button to forward calls to an external phone number. Each outside line may be programmed to either follow or ignore station call forwarding.

Note: The external number to be dialled must be programmed into the system speed dial table

See: MMC 16 Key Extender  
MMC 42 Trunk ON/OFF

### **Call Hold**

Both outside and internal calls can be put on hold at any station. Users may dial the access code or press the HOLD button to retrieve the held call. If you leave the call on hold longer than the hold recall time, it will recall your station.

See: MMC 50 System Timers (Default for RCAL HOLD: 045 sec)

### **Call Hunt**

If this feature is enabled on a station, the intercom call on the station which is busy is transferred to the another station in the same station group.

See: MMC 22 Customer On/Off (Default for CALL HUNT: OFF)

### **Call Metering**

You may make a charge for making outside calls using this feature. This feature is enabled by installing MPD Hybrid ICs on the base board and 4 TRK card. The MPD Hybrid IC detects the metering pulse provided by the Exchange and determines the call cost by the number of metering pulses and the pre-programmed unit cost. The number of metering pulses is displayed on keysets with LCDs. The calculated call cost is printed in the COST column of the SMDR printout.

See: MMC 57 Call Cost

### **Call Pickup**

With directed call pickup, users can answer calls ringing or held at any station by dialling a code plus that station's extension number. In addition, calls can be picked up from a station group in a similar manner. The group pickup feature allows users to answer any call ringing within a pickup group. Using the '\*' button, users can pick up the call ringing in his/her own pickup group.

See: MMC 34 Assign Pickup Group  
MMC 70 Dial Number Plan (Default code for Direct Pickup DPC: 10)  
(Default code for Group Pickup GPC: 66)  
(Default code for Universal Pickup UPC: 67)

## Call Waiting / Camp-on

Busy stations are notified that a call is waiting (camped-on) when they receive a tone. The tone will be repeated at a programmable interval. Keysets receive an off-hook ring signal through the speaker and single line stations receive a tone in the handset. The volume of the camp-on tone can be set by the station user.

See: MMC 50 System Timers (default OFF HOOK RING INTERVAL: 015 sec)

## Centrex / PBX Use

Centrex and PBX lines can be installed instead of C.O trunks. Feature codes and the hook flash command can be stored under one-touch buttons. Toll restriction programming ignores PBX or Centrex access codes so toll calls can be controlled when using these services.

See: MMC 62 PBX Access Code

## Chain Dialling

Station users may manually dial additional digits following a speed dial call or chain together as many speed dial numbers as required.

See: MMC 16 Key Extender  
MMC 17 Station Speed Dial  
MMC 71 System Key Programming  
MMC 62 Station Key Programming

## Class Of Service

System programming allows stations to be assigned one of six outgoing call restriction level. Refer to TOLL RESTRICTION feature.

## Conference

Any combination of up to five (5) parties (stations or outside lines) can be joined together in an add-on conference. A station user may set up a conference with two or more outside lines and then exit the conference leaving the outside lines connected in an unsupervised (trunk to trunk) conference. Parties may be eliminated or added after a conference has been established.

## Database Printout

Customer data can be printed out. This printout can be directed to a PC and can be done on-site. The database may be printed in its entirety or by specific MMC; for instance, directory names or speed dial lists.

See: MMC 80 I/O Parameter

## Data Security

Single line stations used with modems and facsimile machines can be programmed so that they will not receive any system-generated tones that would disrupt data transmissions.

See: MMC 39 Data Line

## Direct In Lines

Outside lines may be programmed to bypass the operator(s) and ring directly at any station, group of stations or paging system.

See: MMC 43 Assign Trunk Ring

## Direct Inward System Access (DISA)

Users can call in on specific DISA lines at any time and receive system dial tone or the preprogrammed voice messages. If you want to make an internal call, dial the station number or station group number. If you want to make an outside call, you must dial the trunk access code. After a short beep tone, an outside caller has to dial his/her station number and station passcode. If the passcode is correct, the system provides the system dial tone again. The user can then dial the outside call number. Some loss of volume may be experienced when connecting two outside lines together. DISA lines can be used as both-way lines or incoming only.

See: MMC 46 Assign Disa Line  
MMC 01 Change User Passcode

## DISA Voice Announcement (Available on the Optional DPH/Paging card).

With this option, specified DISA lines may use Customer-programmed voice messages instead of the system tones. The user will be given a voice prompt, explaining how to proceed with the DISA call.

See: MMC 42 Trunk On/Off (Default Code for VOICE MSG RECORDING: 18)

## Direct Trunk Selection

Each station can directly select a specific C.O. line simply by pressing a button. This can be used to either answer or originate a call.

## Directory Names

Each station and C.O. line may be assigned an associated directory name.

See: MMC 14 Station Name  
MMC 44 Trunk Name

## Distinctive Ringing

Users will know the type of call received by the type of ring heard. Outside calls have a double ring repeated while internal calls have a single ring repeated.

## Door Lock Release (Programmable)

After answering a call from the door phone, user can dial a code to activate a contact closure. This can be used to operate a customer-provided electric door release mechanism. The contact closure timer is programmable from 100-9900 milliseconds.

See: MMC 50 System Timers (Default for DOOR LOCK RELEASE: 100 - 9900 msec)

## Door phone Operation

The system provides for connection of two door phones. Pressing the button on the door phone sounds a distinctive ring at the assigned stations. If not answered, the system will release the door phone and stop ringing after a pre-programmed duration. Stations may call the door phone directly and monitor the surrounding areas. Door phones can be programmed with a day ring destination and a night ring destination.

See: MMC 33 Assign Door Ring

MMC 50 System Timers (Default for DOOR RING OFF TIMER: 1 - 255 SEC)

## Door phone Day/Night Ring

A different door phone ringing position can be programmed for day and for night.

See: MMC 33 Assign Door Ring

## Emergency Call

The system provides a maximum of five urgent codes. These codes can be accessed by any class of service and are useful to allow access to emergency numbers.

See: MMC 64 Override Table

## External Music Interface

Although the system provides internal music on hold chimes, a modular jack is also provided to connect a customer-provided music source for music on hold and background music to keysets.

## External Page Interface

A paging voice pair with 600 ohm impedance is provided for connection to a customer-provided paging system. The contacts can be wired for either normally open or normally closed operation. They can be used to mute music during page announcements.

## Flash Key Operation

While on an outside line, pressing the FLASH key will flash the central office or PBX. This is used for custom calling features on C.O. lines or in conjunction with Centrex/PBX operation. System programming allows flash times for C.O. and PBX lines.

See: MMC 53 Trunk Wide Timers (Default time for NEW CALL: 2000 msec)  
(Default time for FLASH PBX: 600 msec)

## Flexible Numbering

System programming allows stations to have 2- or 3-digit station numbers which may be changed by programming. These will affect the trunk numbers and other feature IDs.

See: MMC 70 Dial Numbering Plan

## Flexible Ringing

Incoming outside calls can be assigned to ring a station or a station group. The system provides separate ringing locations for all trunks in both the DAY and the NIGHT modes.

See: MMC 43 Assign Trunk Ring

## Hot/Warm Line

Stations can be programmed to call a pre-defined station, station group, outside line, trunk group or speed dial number whenever the station goes off-hook. A hot line delay time of 1-9 seconds can be programmed to allow sufficient time to make a different call.

See: MMC 25 Hot/Warm Line

## In Group / Out Of Group

Individuals assigned to a station hunt group may temporarily remove their telephones from the group by pressing the IOG button. Stations out of a group will not receive calls to that group but will continue to receive calls to their individual extension numbers. When desired, the user may put him/herself back into the group by pressing the button again. Users who do not have this button can dial the access code.

See: MMC 70 Dial Numbering Plan (Default Code for In/Out of Group IOG: 53)  
MMC 71 System Key Programming  
MMC 72 Station Key Programming

## Incoming Call Distribution

Incoming calls can be assigned to ring a distributed station hunt group. This will allow all members of the group to share the call load.

See: MMC 35 Station Group  
MMC 43 Trunk Ring

## Incoming / Outgoing Service

Outside lines are available for incoming or outgoing service. Programming allows any outside line to be used for incoming calls only, outgoing calls only or both-service.

See: MMC 31 Ext/Trk Use

## Individual Line Control

Each station in the system can be individually programmed to allow or deny dialling out as well as allow or deny answering for each outside line.

See: MMC 31 Ext/Trk Use

## Live System Programming

The system can be programmed from any display keyset without interrupting normal system operation. There are three levels of programming: technician and customer access are controlled by different security passcode.

See: MMC 20 Open Programming  
MMC 21 Change Passcode

### *Technician Level*

Technician level has access to all programs and can allow the customer access to system programs as needed.

### *Customer Level*

This level requires customer passcodes. It provides access to station programs and system programs allowed by the technician in MMC 90. The system allows the customer to have access to certain MMCs. The MMC ranges which customers can access can be changed by programming.

See: MMC 90 Customer Use MMC

### *Station Level*

All keysets can access station programs 10-17 without using a passcode. Each user can only change data for his/her own keyset.

## Meet Me Page and Answer

After a user makes an "All page" Call, the user may remain off-hook to allow the paged party to meet the user for a private conversation.

### **Examples:**

To use MEET ME PAGE: PRESS FLASH (or Hook/Flash) + System code 56

To use MEET ME ANSWER: Press system code 56

## Message Waiting Indication

When calling a station and receiving a busy signal or no answer condition, the caller can leave an indication that a message is waiting. The MESSAGE button will turn on red at the called keyset. A single line phone will receive a distinctive message waiting dial tone. Five message

waiting indications can be left at any station.

See: MMC 70 Dial Numbering Plan (Default Code for Message Set MSL: 41)  
 (Default Code for Message Answer MSA: 43)  
 (Default Code for Message Clear MSC: 42)

MMC 71 System Key Programming  
 MMC 72 Station Key Programming

**Microphone On/Off Per Station**

The microphone can be disabled at any keyset. When a microphone is disabled, the user cannot use the keyset's speakerphone, although on-hook dialling and group listening are still possible. This feature does not apply to an NX-6B keyset.

See: MMC 22 Customer On/Off (Default: MIKE ON)

**Night Service**

There are two kinds of night services: manual and automatic.

***Manual Night Service***

By pressing the Night Service Button (NIT) , the system can enter the night service mode. In this mode, the NIT button is lit red. In day service mode, the NIT button turns off.

See: MMC 71 System Key Programming  
 MMC 72 Station Key Programming

***Automatic Night Service***

Automatic night service allows the system to automatically go in and out of night service according to the system clock. This feature can be overridden by a manual night service button.

See: MMC 56 Assign Auto Night Time

**Off Premises Extension (OPX)**

A single line (tip and ring) extension may be connected to telephone company-provided OPX circuits to remote locations(maximum 4 km).

**Operator Group**

Stations can be assigned to the operator group for answering incoming calls. Calls to this group can be set for distributed, sequential, conditional, or unconditional ringing. Operators can use the In/Out of Group feature to meet flexible operator requirements. Group 500 is reserved for the operator group and is called by dialling '0'.

See: MMC 35 Assign Station Group

## Overflow

When calls ringing a station group go unanswered, they can overflow to another destination after a preprogrammed period of time. Each station group has its own timer. The overflow destination can be a station, station group or ring over page.

See: MMC 50 System Timers

## Paging

The system allows for the use of four internal zones and one external zone. Stations can page any individual zone, all internal zones, an external zone, or all zones. Using system programming, each keyset may be allowed or denied the making or receiving of page announcements to/from any zone.

See: MMC 23 Page Zone (Internal Page Zone 1, 2, 3, or 4  
 All Internal Page: 0  
 External Page: 5  
 All Internal and External Page: \*)

MMC 22 Customer On/Off (Default for PAGE USE: ON)  
 (Default for PAGE RECEIVE: ON )

MMC 50 System Timers (Default Timer for PAGE TIME OUT : 20 sec)

## Pause Dial

When dialling an outside call, press the Pause (PSE) button to insert a few seconds, pre-programmed, pause. (The PSE button is programmed with the required value.)

See: MMC 71 System Key Programming  
 MMC 72 Station Key Programming

## Port Status Check

Users can see the port status through the keyset LCD. There are sixteen (16) status types: IDLE, BUSY, CALLBACK, PROGRAM, etc.

See: MMC 92 Port Status

## Power Failure Transfer

In the event of power loss to the system, the first two outside lines can be automatically connected to the last two single line stations . When power is restored to the system, the lines and stations will return to normal operation. Calls in progress will be disconnected.

## Prime Line Selection

Any station can be programmed to select a specific line, line group, telephone number, station or station group.

## Private Lines

For private line use, stations can be prevented from dialling and/or answering any line.

See: MMC 31 Ext/Trk use

## Programmable Line Privacy

Each outside line can be programmed to ignore the automatic line privacy. This allows up to four other parties to join a conversation by simply pressing the line button. This is similar to 1A2 key telephone operation.

See: MMC 42 Trunk On/Off (1A2 EMULATION)

## Programmable Timers

There are a number of programmable system timers to allow each installation to be customised to best fit the user's application.

See: MMC 50 System Timers

## Recalls

Calls put on hold, transferred or camped-on to any station will recall to the originating station if not answered within a programmable period of time. A recall that goes unanswered for the same period of time will recall to the system operator group. Hold and transfer recalls each have their own individual programmable timer.

See: MMC 50 System Timers

## Remote Programming (option)

NX-828's remote programming allows the technician to access the system database from a remote location to make programming changes. A traffic report can be remotely requested for use as a troubleshooting aid. A customer-provided modem and PC can also be connected directly to the RS-232C DB9 connector on the optional SMDR/R-MMC card for on-site programming.

See: MMC 80 I/O Parameter

## Ring Over Page

A system-generated ring tone can be programmed on a per-line basis to go out over a customer-provided external paging system when the system is in night mode.

See: MMC 42 Trunk On/Off (Default for RING OVER PAGE: OFF)

## Single Line Connections

Single line ports allow for connection of a variety of single line telephones plus facsimile machines, answering machines, loud bells, computer modems, cordless phones and credit card machines. When connecting customer-provided equipment to these extensions, compatibility should be checked out before purchase to ensure correct operation. Connecting single line telephones (SLT) to the system requires some programming according to the type of SLTs connected.

### ***According to SLT type:***

DTMF Type  
DIAL PULSE Type

See: MMC 38 SLT Type

### ***SLT Related Timers***

HOOK OFF  
SLT FLASH MIN  
SLT FLASH MAX

See: MMC 50 System Timers

### ***For Data Security***

See: MMC 39 Data Line

## Speed Dial Numbers

### ***Station Speed Dial***

Each station has 20 speed dial numbers (00-19). Each speed dial number may contain up to 30 digits.

See: MMC 17 Station Speed Dial

### ***System Speed Dial***

The system has 80 speed dial numbers (20-99). Each speed dial number may contain up to 30 digits. The system speed dial numbers can be used by any station.

See: MMC 67 Assign System Speed Dial

## Station Hunt Groups

System programming allows for up to 20 station groups. One of four ring patterns is

available for each group: SEQUENTIAL, DISTRIBUTE, CONDITION or UNCONDITION. Each group may contain a maximum of eight (8) stations and a station may be contained in only one group at any one time. Group 500 is reserved for the operator group and is called by dialling '0'. Each station group has its own recall time for calls transferred to that group.

See: MMC 35 Assign Station Group

MMC 70 Dial Number Plan (Default Station Groups SGR: 500-519)  
(Default Operator Group OPR: 0)

## Station Message Detail Recording (SMDR)

The system provides records of calls made, received and transferred. Each call record provides details of the station number, outside line number, date, start time, duration of calls, digits dialled (maximum 18), an account code, (if entered), an Authorisation code (if required) and call Cost. If the MPD card is installed in the system, the calculated call cost is printed in the COST column. A Display keyset will show the number of Meter pulses received.

The SMDR format contains many options that allow it to be customised for a company's individual needs. Options to print include incoming calls and authorisation codes. See sample printout at the end of this section.

See: MMC 80 I/O Parameter  
MMC 81 SMDR Options

## Station To Station Calling Restriction

Stations can be prevented from calling other stations.

See: MMC 32 Intercom Use

## System Directory

Each station and outside line can have a 12-character directory name. This name will appear on keyset displays to provide additional information about lines and stations.

See: MMC 14 Station Name  
MMC 44 Trunk Name

## System Halt

This is used only when all data processing needs to be stopped. This feature requires technician programming level and, therefore, the technician's passcode.

See: MMC 94 Halt Process

## Toll Restriction

There are 250 allow and 250 deny entries of 11 digits each. Each of these entries can apply to dialling classes B, C, D and E. Class A stations have no dialling restrictions and class F stations cannot make outside calls.

See: MMC 30 Station Toll Class  
MMC 60 Toll Deny Table / Apply  
MMC 61 Toll Allow Table / Apply  
MMC 65 Assign Wild Character

## Toll Restriction Override

There are several methods of toll restriction override as described below.

### ***System Speed Dial Toll Restriction Override***

Program options allow for system speed dial numbers to follow or bypass a station's toll restriction class.

See: MMC 66 System Speed Dial Toll Restriction

### ***Authorization Code***

Authorisation codes are used to validate a station user and give permission to make a call. Each authorisation code has an associated toll class. When the code is entered, the station toll class is changed to that of the authorisation code.

See: MMC 63 Authorization Code

### ***Walking Class of Service***

You can change a restricted station's toll class to the same class as your station by entering the walking class of service (COS) ID, the station number and the station's passcode. The default station passcode 1234 cannot be used.

See: MMC 70 Dial Numbering Plan (Default Code for COS: 59)

### ***Urgent Code***

The system provides a maximum of five urgent codes. These codes can be accessed by any class of service and are useful for allowing access to emergency numbers.

See: MMC 64 Override Table

## Tone Or Pulse Dialling

Outside lines can be programmed for either tone or pulse dialling to meet local telephone company requirements.

See: MMC 41 Trunk Dialling Type

## Traffic Report Printout

The traffic report prints system-wide totals for incoming calls, outgoing calls and intercom calls. This report also shows the number of outside calls made and answered, as well as the number of intercom calls made and answered for each station. This report can be set for automatic printout at the end of each day or at the end of every week. The report can also be printed on demand. A customer-provided printer must be connected to the SMDR port or R-MMC port to print this report.

See: MMC 80 I/O Parameter  
MMC 83 Call Traffic Report

## Transfer

System operation permits station users to transfer calls to another station in the system. Transfers can be screened , unscreened or camped-on to a busy station.

## Trunk Disconnect Signal

Systems can recognise a trunk disconnect signal generated by central office when an outside party hangs up. The system receives this signal and the call is hung up automatically.

See: MMC 53 Trunk-Wide Timers (CO SUPV TIME)

## Trunk Groups

Outside lines can be grouped for easy access by dialling a code or pressing a button. There are 11 trunk groups available. Access codes are 9 and 80-89.

See: MMC 45 Trunk Group

## Universal Night Answer (UNA)

Stations may dial the Universal Night Answer (UNA) code to answer any outside lines programmed to ring over the paging system.

See: MMC 42 Trunk On/Off (Default for RING OVER PAGE: Off)

## 1.2 Station Features

ADD-ON MODULE (AOM)	MESSAGE WAITING LIGHT / INDICATION
APPOINTMENT REMINDER	MUTE MICROPHONE / HANDSET
AUTOMATIC HOLD	OFF-HOOK RINGING
AUTOMATIC PRIVACY	ON-HOOK DIALLING
BACKGROUND MUSIC	ONE TOUCH DIALLING KEYS
BUSY STATION CALLBACK	PROGRAMMABLE KEYS
BUSY STATION INDICATION (BLF)	PROTECTION FROM BARGE-IN
DIRECT STATION SELECTION (DSS)	PULLOUT DIRECTORY TRAY
DO NOT DISTURB (Programmable)	PULSE TO TONE SWITCHOVER
DOOR LOCK RELEASE	REDIAL
EXCLUSIVE HOLD	Automatic Redial
EXECUTIVE/SECRETARY HOT LINES	Last Number Redial
FORCED AUTO ANSWER	Saved Number Redial
GROUP LISTENING	RING MODES
HEADSET OPERATION	Ring Mode
HEARING AID COMPATIBLE	Auto Answer Mode
HOT KEYPAD	Voice Announce Mode
KEY TONE SELECTION	RINGING LINE PREFERENCE
LINE QUEUING WITH CALLBACK	SPEAKER PHONE
LINE SKIPPING	STATION LOCK
	TRI-COLOURED LIGHTS
	VACANT STATION MESSAGES
	VOLUME SETTINGS
	WALL-MOUNTABLE KEYSSETS

### Add-On Module

NX-828's unique add-on module (AOM) adds to the capability of a station. Its 24 programmable buttons can be used for feature keys, DSS/BLF keys or one-touch speed dial buttons. Note only one AOM can be assigned to a station.

See: MMC 37 Assign AOM  
 MMC 71 System Key Programming

### Appointment Reminder

Stations can be used like an alarm clock. Program in a specific time and the keyset will give a distinctive ring to remind you of meetings or appointments. Alarms can be set for 'DAY' or 'DAILY'. Up to three alarms may be set at each keyset.

See: MMC 26 Alarm Reminder

### Automatic Hold

Station users can enable or disable automatic hold at their individual keysets. While the user is engaged on an outside call, pressing another trunk key automatically puts the call

on hold when this feature is enabled. Pressing the TRANSFER, CONFERENCE, PAGE or DSS key always puts calls on hold. This type of automatic hold is not a user-selectable option.

See: MMC 12 Station On/Off (Default for AUTO HOLD: OFF)

## **Automatic Privacy**

All conversations on outside lines and intercom calls are automatically private. The privacy feature can be turned off on a per-line basis.

## **Background Music**

The HOLD button turns BGM on or off.

See: MMC 22 Customer On/Off (Default for BGM: ON)

## **Busy Station Callback**

When reaching a busy station, callers may request a callback by pressing one button or dialling a code (44). The system rings the caller back when that station becomes idle.

## **Busy Station Indication (BLF)**

DSS/BLF keys may be assigned to any keyset or AOM. These buttons will be off when the station is idle, lit red when that station is in use and will flash when that station is in Do Not Disturb (DND) mode.

## **Direct Station Selection (DSS)**

Soft keys can be programmed with extension numbers. Users press these keys to make or transfer calls to the assigned stations.

## **Do Not Disturb (Programmable)**

The DND feature is used to stop all calls to a station. System programming can allow or deny use of the DND feature for each station. Parties calling a station in DND mode will receive a distinct DND tone.

See: MMC 22 Customer On/Off (Default for DND: ON)

## **Door Lock Release**

Stations programmed to receive calls from a door phone can dial a code to activate a contact closure for control of a customer-provided electronic door lock.

See: MMC 50 System Timers (Default for DOOR RELEASE TIMER: 100 - 9900 msec)

## Exclusive Hold

Pressing the HOLD button twice will hold a call exclusively at that station. No other station can pick up the call.

See: MMC 50 System Timers (Default for RECAL HOLD TIMER: 045 sec)

## Executive / Secretary Hot Lines

An immediate hands-free communication link is established when the EXECUTIVE/SECRETARY button is pressed. When the EXECUTIVE is in DND mode, all calls are forwarded to the SECRETARY and only the SECRETARY can call the EXECUTIVE. This feature is only available between two keysets. Each SECRETARY can have up to two EXECUTIVES. An EXECUTIVE station has only one SECRETARY.

See: MMC 36 Assign Boss/Secretary

## Forced Auto Answer

The called station automatically answers on the speakerphone. Callers may request this feature by pressing one button or dialling a code (14).

See: MMC 72 Station Key Programming

## Group Listening

A keyset assigned this feature button may turn on the speaker while using the handset. This allows a group of people to listen to the distant party over the speaker without turning on the microphone.

See: MMC 72 Station Key Programming

## Headset Operation

Every keyset can be programmed to allow for the use of a headset. In headset mode, the hookswitch is disabled and the SPEAKER button is used to answer calls.

See: MMC 12 Station On/Off (Default for HEADSET USE: OFF)

## Hearing Aid Compatible

All NX keysets are hearing aid compatible as required by part 68 of the FCC requirements.

## Hot Keypad

If hot keypad is enabled, it is no longer necessary to lift the handset or press SPEAKER button before you begin dialling.

See: MMC 12 Station On/Off (Default for HOT KEYPAD: ON)

## Key Tone Selection

This feature allows users to hear a slight tone when pressing the keypad on their keyset.

See: MMC 12 Station On/Off (Default for KEY TONE: ON)

## Line Queuing With Callback

When the desired outside line is busy, the user can press the CALLBACK key or dial the access code to place his/her station in a queue. The user will be called back when the line is available

## Line Skipping

When a user is talking on an outside line and automatic hold is turned off, the user may directly press another line key without causing the previous call to go on hold.

## Message Waiting Light / Indication

When a message indication is left at a keyset, the MESSAGE button will light red. Single line telephone users will receive a few seconds of interrupted dial tone to notify them that a message is waiting. Message waiting indications can be left for any station or group of stations.

## Mute Microphone / Handset

On NX keysets, pressing the MUTE key will cut off the microphone or the handset transmitter, depending on which is in use. NX-6B keyset users cannot use this feature.

## Off-Hook Ringing

When a keyset is in use, the system will provide an off-hook ring signal to indicate that another call is waiting. The ring signal is a single repeated ring. The interval is controlled by a system-wide timer. Single line stations will receive a tone burst through the handset instead of a ring.

## On-Hook Dialling

Any keyset user can originate calls without lifting the handset. When the called party answers, speak into the microphone or lift the handset for more privacy.

## One-Touch Dialling Keys

Frequently-used speed numbers can be assigned to one-touch dialling keys for fast accurate dialling.

See: MMC 72 Station Key Programming

## Programmable Keys

NX keysets have programmable soft keys. Each soft key can be programmed for over 36 different uses to personalise each phone. Examples of soft keys include: individual outside line, individual station line, group of lines, group of stations and one-touch dialling. Using these soft keys eliminates dialling access codes. The following soft keys have extenders that identify what station, group or number that feature key applies to: speed dial, page, directed pickup, group pickup, door phone and vacant messages.

See: MMC 72 Station Key Programming

## Pullout Directory Tray

A pullout directory tray is conveniently located beneath all keysets. Use this to record station directory names and speed dial numbers.

## Pulse To Tone Switchover

When dialling a number on a dial pulse network, a station user can dial # and the system will begin to send DTMF.

## Redial

There are three types of external redial available to all station users, as described below.

### ***Automatic Redial***

When a user dials an outside number and receives a busy signal, the automatic redial feature is used to reserve the outside line and automatically redial the number for a programmable number of attempts.

See: MMC 50 System Timers  
MMC 52 System-Wide Counters  
MMC 72 Station Key Programming

### ***Last Number Redial***

The most recent number dialled on a C.O. line is saved and may be redialled by pressing the REDIAL button or dialling the LNR ID.

See: MMC 72 Station Key Programming

### ***Saved Number Redial***

Any number dialled on a C.O. line may be saved by pressing the pre-programmed SNR button or dialling the SNR feature code (17) for redial at a later time. It may be redialled by pressing the SNR button or dialling the SNR ID.

See: MMC 70 Dial Numbering Plan (Default Code for SNR: 17)  
MMC 72 Station Key Programming

## Ring Modes

Each keyset user can select one of three ways to receive intercom calls, as described below. The phone can automatically answer on the speakerphone, voice announce through the speaker or receive ringing.

### ***Ring Mode***

Calls are answered by pressing the SPEAKER button or by lifting the handset.

### ***Auto Answer Mode***

The keyset will automatically answer calls on the speakerphone.

### ***Voice Announce Mode***

Keyset users can hear the caller's voice, but the caller cannot hear the user's voice. For the caller to hear the user's voice, the user presses the SPEAKER button or lifts the handset.

See: MMC 10 Set Answer Mode

## Ringling Line Preference

Lifting the handset or pressing the SPEAKER button will automatically answer a call ringing the keyset. Using this method, users will be assured of answering the oldest call first. When ringing preference is turned off, the user must press the flashing button to answer. Users may answer ringing lines in any order by pressing the flashing button.

See: MMC 12 Station On/Off (Default for RING PREFERENCE: ON)

## Speaker Phone

Keysets (except NX-6B keysets) have a built-in speakerphone. If the microphone is enabled on the keyset, calls can be made and received without using the handset.

See: MMC 22 Customer On/Off (Default for MIKE: ON)

## Station Lock

Station locking prohibits another user from using your station. The system provides two kinds of locking: when LOCKED1 is selected, dialling on your station is prohibited but answering calls is permitted; when LOCKED2 is selected, both dialling and answering calls are prohibited. In UNLOCK condition, you can dial and answer calls as normal.

See: MMC 00 Station Lock (Default for STATION LOCK: UNLOCKED)

## Tri-Coloured Lights

Keysets have tri-coloured LEDs. Outside calls in use at a keyset light green at that station and red at all others. Recalls to these keys will have an amber light (red and green together).

## Vacant Station Messages

Any keyset may select one of 20 messages to be displayed at a calling party's keyset. 10 messages are fixed and 10 can be customised by the system administrator. (16 characters maximum per message). The 10 fixed messages are:

01 IN A MEETING	02 OUT ON A CALL	03 OUT TO LUNCH
04 LEAVE A MESSAGE	05 PAGE ME	06 OUT OF TOWN
07 IN TOMORROW	08 RETURN AFTERNOON	
09 ON VACATION	10 GONE HOME	

NOTE : The calling party must have a display keyset to view these messages.

See: MMC 27 Vacant Message

## Volume Settings

Each keyset may separately adjust the volume of the ringer, speaker and handset receiver. NX keysets use VOLUME (+) and (-) to adjust volume levels.

## Wall-Mountable Keysets

Every keyset and AOM comes equipped with a reversible base wedge.

## 1.3 Display Features

ACCOUNT CODE DISPLAY	ENHANCED STATION PROGRAMMING
CALL DURATION TIMER	IDENTIFICATION OF RECALLS
CALL FOR GROUP IDENTIFICATION	IDENTIFICATION OF TRANSFERS
CALL PROCESSING INFORMATION	MESSAGE WAITING CALLER NUMBER
CALLING PARTY NAME	MULTI-LANGUAGE DISPLAY (3)
CALLING PARTY NUMBER	OUTSIDE LINE IDENTIFICATION
CONFERENCE INFORMATION	STOPWATCH TIMER
DATE AND TIME DISPLAY (4 types)	VACANT STATION MESSAGE DISPLAY
DIALLED NUMBER	

### Account Code Display

Account codes are conveniently displayed for easy confirmation. If entered incorrectly, users may press the ACC key again and re-enter the account code.

### Call Duration Timer

The system can automatically time outgoing calls and show the duration in hours, minutes and seconds. Station users may manually time calls by pressing the TIMER.

See: MMC 12 Station On/Off (DEFAULT FOR AUTO TIMER: ON)

### Call For Group Identification

When a call is made to a station group, the display will show the user's group number. These calls can be answered with a different greeting than calls to the user's extension number.

### Call Processing Information

During everyday call handling, the keyset display will provide information that is helpful and in some cases invaluable. In some conditions the user is prompted to take action and in other cases the user receives directory information.

### Calling Party Name

For intercom calls, display keysets show the calling party's name when answering. The names must be stored in the system directory list and can be up to 12 characters long.

See: MMC 14 Station Name

## Calling Party Number

When receiving an intercom call, all display stations show the calling party's extension number.

## Conference Information

When setting up a conference, each extension and outside line number is displayed at the controlling station when it is added. When a station is added to a conference, its display will show [CONFERENCE 203] alerting the user that other parties are on the line.

## Date And Time Display

In the idle condition, the current date and time are conveniently displayed. Keysets can have a 12 - or 24-hour clock in either an EASTERN or WESTERN display format.

See: MMC 15 Date Display

## Dialled Number

When making outside calls, the digits dialled are displayed as the user dials them. If the display indicates an incorrect number has been dialled, the user can quickly hang up before billing begins.

## Enhanced Station Programming

Personal programming options are easier to select and confirm with the help of the display.

## Identification Of Recalls

Hold recalls and transfer recalls are identified differently. Hold recalls show [HOLD RECALL 203] and transfer recalls show e.g. [RECALL FROM 204].

## Identification Of Transfers

The display identifies who has transferred a call to the user (e.g. [TRSF. FROM 206]) and also shows when a call is camped-on to the user's station.

## Message Waiting Caller Number

When the message indication is on, pressing the MESSAGE button will display the station number of the person who has messages for the user. Display keysets scroll up and down to show message indications.

## Multi-Language Display (3)

One of three languages can be displayed on an LCD, as selected by the user. The languages available are listed below with their entry numbers.

Entry No.	Language
1	English
2	Spanish
3	Portuguese

NOTE : When users are in MMC mode, English is displayed on the LCD.

See: MMC 93 Selection Languages

## Outside Line Identification

Each line can be identified with a name or ID. Incoming calls ringing at your station will display this ID before the call is answered. This is helpful when lines need to be answered with different greetings.

See: MMC 44 Trunk Name

## Stopwatch Timer

Display keyset users will find this feature very convenient to time meetings, calls and other functions. Users simply press to start the timer and press again to stop the timer.

## Vacant Station Message Display

Vacant station messages set by other stations can be viewed at the user's station when he/she calls them.

See: MMC 27 Vacant Message

## 2. Feature ID Table

FEATURE	FEATURE ID
Operator Group	0
Hold Pickup Pickup Page Hold Direct Pickup	10 + Station Number/ Trunk Number
Hold	H/F + 11
Call Secretary	12
Call Boss	12 + 1 / 2
Open Doorphone	H/F + 1
Call Doorphone	13 + 1 / 2
Direct Open Doorphone	13 + 3 / 4
Forced Auto Answer	H/F + 14
Programming Personal Speed Dial	15 + Personal Speed Dial Number(00~19) + Telephone Number + H/F
Speed Dial	16 + Speed Dial Number (00 ~ 99)
Saved Number Redial	17
Last Number Redial	19
Leaving a Message	H/F +41,41 + Station/Station Group Number
Cancelling a Message	42 + Station/Station Group Number
Returning a Message	43
Callback	H/F + 44
Camp-On	H/F + 45
Conference	H/F + 46
Account Code	H/F + 47
Vacant Message Setting	48 + message number(01~20)
Vacant Message Cancelling	48 + 00
C.O. Flash (New Call)	H/F + 49
Group In/Out	53 + 1 / 0

FEATURE	FEATURE ID
Station Passcode Changing	54 + old passcode + new passcode
Paging All	55 + *
Paging all internal Zone	55 + 0
Paging internal zone(1~4)	55 + 1 / 2 / 3 / 4
Paging External Zone	55 + 5
Meet Me Page	H/F + 56
Meet Me Answer	56
Alarm Setting	58 + HH + MM
Alarm Cancelling	58 + 3
Walking Class of Service	59 + station number + station passcode
Cancelling Call Forward	60
Call Forward All Setting	61 + 1 + station NO./ station group NO.
Call Forward All Cancelling	61 + 0
Call Forward Busy Setting	62 + 1 + station NO./ station group NO.
Call Forward Busy Cancelling	62 + 0
Call Forward No Answer Setting	63 + 1 + station NO./ station group NO.
Call Forward No Answer Cancelling	63 + 0
DND	64 + 1 / 0
Toll Override	65 + Authorization Code
My Number	#
Group Pickup	66 + pickup group(0~9)
UNA Pickup	67
Answer Mode Setting	68 + 1 / 2 / 3
Headset	69 + 1 / 0
Pickup Group	*
Pulse to Tone Changeover	Dialing + #



# PROGRAMMING

---

# TABLE OF CONTENTS

# PROGRAMMING

<b>1.</b>	<b>Introduction to Programming</b>	
1.1	Programming Overview.....	4- 1
1.2	Programming Levels.....	4- 1
1.3	Program Keys.....	4- 2
<b>2.</b>	<b>Programming Procedures</b>	
2.1	Program List.....	4- 4
2.2	Program Procedures (MMCs).....	4- 5

# 1. Introduction To Programming

## 1.1 Programming Overview

The system arrives from the factory with default data. Connect it to trunks, stations and power, turn the system on and it is fully operational. The only thing left to do is customise the data to fit the customer's needs. This is called programming the system.

MMC stands for Man Machine Code and each program is assigned a different 2-digit code. These MMC are used to view, create or change customer data. Programming is simply deciding what needs to be done and knowing which MMC is used to do it.

System programming may be done from any NX-24E , NX-24B or NX-6B keyset (see 1.3.1), add-on module (AOM) or any keyset with an LCD (see 1.3.2). The first thing you must do is open system programming. As a security measure, a passcode is required in order to do this.

## 1.2 Programming Levels

There are three levels of programming: System, Customer and Station. System and Customer levels are under passcode protection; station programming does not require a passcode.

To prevent conflicting data from being entered, only one person at a time can enter programming with the technician or customer passcode. While programming is in progress, normal system operation is not affected.

### SYSTEM LEVEL

This level is entered via MMC 20 and requires the technician-level passcode. It allows access to all system programs, station programs and maintenance programs.

### CUSTOMER LEVEL

This level is entered via MMC 20 and requires the customer-level passcode. It provides access to station programs and system programs allowed by the technician in MMC 90. When using the customer passcode to access station programs, data for all stations can be viewed or changed.

### STATION LEVEL

All keysets can access station programs 10-17 without using a passcode. Each user can only change data for his/her own keyset.

### 1.3 Program Keys

#### 1.3.1 NX-keyset with LCD

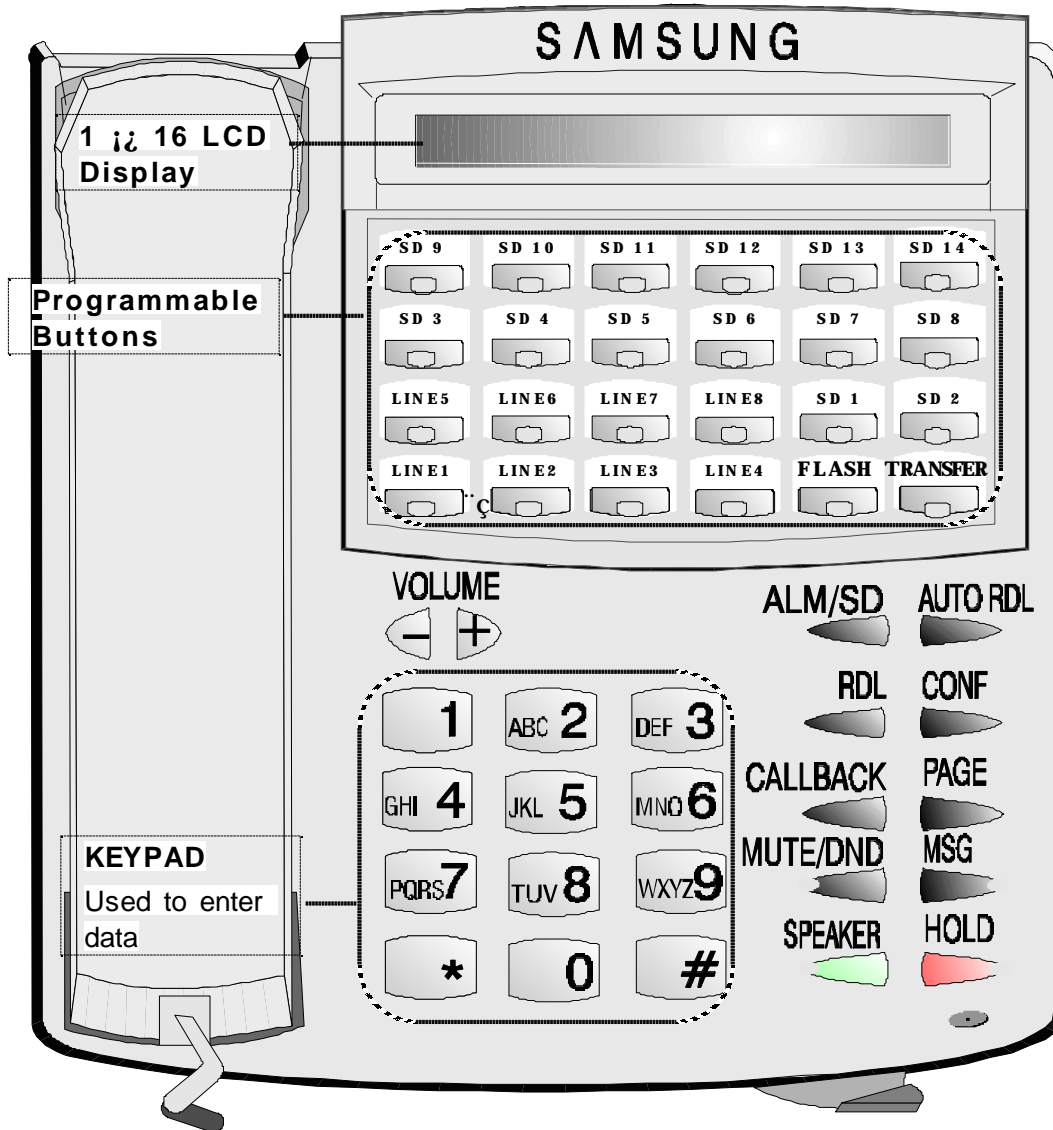

LINE1, LINE2

MUTE/DND or MSG

AUTO RDL

SPEAKER

HOLD

:Scroll through stations or trunks.

:Normally used to select data.

:Enter programming mode. Also used to save changes and exit the program.

:Save changes and advance to the next program.

:Normally used to clear previous data.

### 1.3.2 Other keysets with LCD

If the user has another type of keyset with an LCD, such as the 816 keyset, the keys used for programming are a little different from the NX- keyset. The following table describes these different keys.

<b>NX-keyset</b>	<b>816 keyset</b>
AUTO RDL	AUTO RDL
ALM/SD	ALM/SD
RDL	RD
CONF	CONF
CALLBACK	CALLBACK
PAGE	PAGE
MUTE/DND	MUTE/DND
MSG	MSG
SPEAKER	SPK
HOLD	HOLD
LINE1/LINE2	TIMER/AUTO ANS

## 2. Programming Procedures

### 2.1 Program List

- |                           |                                      |
|---------------------------|--------------------------------------|
| 00: STATION LOCK          | 47: ASSIGN MPD                       |
| 01: CHANGE USER PASSCODE  | 50: SYSTEM TIMERS                    |
| 10: SET ANSWER MODE       | 51: TONE/RING CADENCE                |
| 11: CALL FORWARD          | 52: SYSTEM WIDE COUNTER              |
| 12: STATION ON/OFF        | 53: TRUNK WIDE TIMER                 |
| 13: SET RING FREQUENCY    | 54: MAKE/BREAK RATIO                 |
| 14: STATION NAME          | 55: CURRENT DATE AND TIME            |
| 15: DATE DISPLAY          | 56: ASSIGN AUTO NIGHT TIME           |
| 16: KEY EXTENDER          | 57: CALL COST                        |
| 17: STATION SPEED DIAL    |                                      |
|                           | 60: TOLL DENY TABLE                  |
| 20: OPEN PROGRAMMING      | 61: TOLL ALLOW TABLE                 |
| 21: CHANGE PASSCODE       | 62: PBX ACCESS CODE                  |
| 22: CUSTOMER ON/OFF       | 63: AUTHORIZATION CODE               |
| 23: PAGE ZONE             | 64: OVERRIDE CODE                    |
| 24: ASSIGN BARGE-IN       | 65: ASSIGN WILD CHARACTER            |
| 25: HOT/WARM LINE         | 66: SYSTEM SPD DIAL TOLL RESTRICTION |
| 26: ALARM REMINDER        | 67: ASSIGN SYSTEM SPEED DIAL         |
| 27: VACANT MESSAGE        | 70: DIAL NUMBERING PLAN              |
| 28: CALL DISC             | 71: SYSTEM KEY PROGRAMMING           |
|                           | 72: STATION KEY PROGRAMMING          |
| 30: STATION TOLL CLASS    | 73: KEY TEST                         |
| 31: EXT/TRK USE           |                                      |
| 32: INTERCOM USE          | 80: IO PARAMETER                     |
| 33: ASSIGN DOOR RING      | 81: SMDR OPTION                      |
| 34: ASSIGN PICKUP GROUP   | 83: CALL TRAFFIC REPORT              |
| 35: ASSIGN STATION GROUP  |                                      |
| 36: ASSIGN BOSS/SECRETARY | 90: CUSTOMER USE MMC                 |
| 37: ASSIGN ADD-ON MODULE  | 91: SYSTEM VERSION                   |
| 38: SLT DIALING TYPE      | 92: PORT STATUS                      |
| 39: DATA LINE             | 93: SELECTION LANGUAGE               |
|                           | 94: HALT PROCESS                     |
| 40: C.O./PBX LINE         | 95: SYSTEM RESTART                   |
| 41: TRUNK DIALING TYPE    |                                      |
| 42: TRUNK ON/OFF          |                                      |
| 43: ASSIGN TRUNK RING     |                                      |
| 44: TRUNK NAME            |                                      |
| 45: TRUNK GROUP           |                                      |
| 46: ASSIGN DISA LINE      |                                      |

## 2.2 Program Procedures (MMCs)

The following instructions for each MMC assume that you have already opened programming. To open System (Customer) Programming, the procedure is:

1. Press AUTO RDL then 20
2. Enter customer passcode (default = 1234)
3. Enter 1 to Enable

When you have finished programming in MMCs 00-95 and have other programming to do, press SPEAKER to exit the MMC but remain in programming mode and use one of the following methods:

- dial another MMC code directly and continue programming  
or
- press LINE1 and LINE2 keys to scroll through all MMC codes. When the desired MMC code is displayed, press SPEAKER and continue programming.

Pressing AUTO RDL will always save changes and exit programming mode.



**MMC 00****STATION LOCK****Description:**

Used to lock or unlock stations; e.g. if you want to prohibit another user from using your station.

**UNLOCK** Normal status

**LOCKED1** Prohibits another user from making outside calls.

**LOCKED2** Prohibits another user from dialling or receiving any calls.

**Action**

1. Press **AUTO RDL** and dial **00**

**Display**

201: UNLOCKED

2. Using **LINE1** or **LINE2**, select the station you want(e.g. 202)

202: UNLOCKED

If you want to select all stations, press **LINE1**

3. Press **MUTE/DND** or **MSG** to make selection  
OR  
Using **KEYPAD**, dial  
**0** for **UNLOCKED**  
**1** for **LOCKED1**  
**2** for **LOCKED2**  
(e.g.1)

202: LOCKED1

4. Press **AUTO RDL** to save and exit

**DEFAULT DATA**

UNLOCKED

**RELATED MMC**

MMC 01 CHANGE USER PASSCODE

**MMC 01****CHANGE USER PASSCODE****Description:**

Used to reset any keyset's passcode to its default value '1234' (for example, if the user has forgotten his/her passcode). This MMC cannot display station passcodes. Keyset users can set or change their individual passcodes. The passcode is used to lock or unlock the keyset and to access the walking class of service and DISA calls.

NOTE : The following features will not work with the Default Password.  
(Station lock, DISA calls, and walking class of service).

**Action**

1. Press **AUTO RDL** and dial **01**
  
2. Using **LINE1** or **LINE2**, select the station you want (e.g. 202)
 

If you want to select all stations, press LINE1
  
3. Press **HOLD** to reset selected station's passcode to default data (1234)
  
4. Press **AUTO RDL** to save and exit

**Display**

201: DEFAULT?

202: DEFAULT?

202: DEFAULT!

**DEFAULT DATA**

1234

**RELATED MMC**

MMC 00 STATION LOCK  
MMC 46 ASSIGN DISA LINE



# MMC 11 CALL FORWARD

**Description:**

Used to program the call forward destination for other station users and set the time for FORWARD NO ANSWER. Each station can forward calls under the following conditions:

<b>FORWARD ALL</b>	All calls are forward to destination station
<b>FORWARD BUSY</b>	If the station is busy, calls are forward to destination.
<b>FORWARD NO ANSWER</b>	If the station doesn't answer in 'no answer' time, calls are forward to destination.
<b>NO ANSWER TIME</b>	Used to set no answer time. This time also used for External Call Forward.

**Action**

**Display**

1. Press **AUTO RDL** and dial **11**

201: F ALL:

2. Using **LINE1** or **LINE2**, select the station you want (e.g. 202)

202: F ALL:

3. Press **RDL** or **CONF** to select the forward type described above(e.g. FORWARD NO ANSWER)

202: F NOA:

4. Enter the destination station (e.g. 203)

202: F NOA:203

If you want to clear the data, press **HOLD**  
 If your selection is **NO ANSWER TIME**, enter 3-digit time in seconds (default = 015sec)

202: TIME: 015S

5. Press **AUTO RDL** to save and exit

**DEFAULT DATA :** FORWARD TYPE: NONE  
 NO ANSWER TIME: 015 SEC

**RELATED MMC :** NONE



***DEFAULT DATA***

AUTO HOLD : OFF  
AUTO TIMER : ON  
HEADSET : OFF  
HOT KEYPAD : ON  
KEY TONE : ON  
RING PREFERENCE : ON

***RELATED MMC***

NONE

**MMC 13****SET RING FREQUENCY****Description:**

Used to select the ring frequency at each keyset. Four types of ring frequency are available. A short tone burst of the selection will be heard when the dial keypad is pressed.

**Action**

1. Press **AUTO RDL** and dial **13**  
Display shows current frequency
2. Using **RDL** or **CONF**, select the station you want  
(e.g. 202)

If you want to select all stations, press RDL

3. Pressing **MUTE/DND** or **MSG** to makes election.  
A short burst tone of selection will be heard  
OR  
Using keypad, dial

- 1 for FREQUENCY 1**
- 2 for FREQUENCY 2**
- 3 for FREQUENCY 3**
- 4 for FREQUENCY 4 (e.g. 2)**

4. Press **AUTO RDL** to save and exit

**Display**

201: FREQ. 1

202: FREQ. 1

202: FREQ. 2

**DEFAULT DATA**

FREQUENCY 1

**RELATED MMC**

NONE

# MMC 14 STATION NAME

**Description:**

Used to enter a 12-character name to identify an individual station. Names are written using the keypad. Each press of a key selects a character. Pressing another dial pad key will move the cursor to the next position.

For example if the station name is "SAM SMITH", press the number "7" four times to get the letter "S", and so on to enter the whole name. The characters programmed for each keypad are listed below.

dial count \	1	2	3	4	5	6	7	8	9	0	*	#
1	█	A	D	G	J	M	P	T	W	:	?	
2	1	B	E	H	K	N	Q	U	X	.	&	[
3		C	F	I	L	O	R	V	Y	!	\$	]
4		2	3	4	5	6	S	8	Z	0	*	#
5							7		9			

**NOTE :** When the character you want appears on the same dial pad key as the previous character, press CONF to move the cursor to the right.

**Action**

**Display**

1. Press **AUTO RDL** and dial **14**

201:NX828

2. Using **LINE1** or **LINE2**, select the station you want (e.g. 202)

202:

3. Using the table above, enter the station name  
Use **CONF** to move cursor right (up to 12 digits)

202:SAM SMITH

4. Press **AUTO RDL** to save and exit

**DEFAULT DATA**

NX 828

**RELATED MMC**

NONE

# MMC 15

# DATE DISPLAY

**Description:**

Used to change the date display mode of each station. Date display modes are:

- |   |                   |                  |
|---|-------------------|------------------|
| 1 | <b>24 WESTERN</b> | WED 21 JUN 17:37 |
| 2 | <b>12 WESTERN</b> | WED 21 JUN 05:37 |
| 3 | <b>24 EASTERN</b> | 06/21 WED 17:37  |
| 4 | <b>12 EASTERN</b> | 06/21 WED 05:37  |

SKP-816 model keysets display western mode only.

**Action**

**Display**

1. Press **AUTO RDL** and dial **15**

201: 12 WESTERN

2. Using **LINE1** or **LINE2**, select the station you want (e.g. 202)

202: 12 WESTERN

If you want to select all stations, press **LINE1**

3. Pressing **MUTE/DND** or **MSG** to make selection  
OR

202: 24 EASTERN

Using KEYPAD, dial

- 1 for 24 WESTERN**
- 2 for 12 WESTERN**

4. Press **AUTO RDL** to save and exit

**DEFAULT DATA**

12 WESTERN

**RELATED MMC**

MMC 55 CURRENT DATE AND TIME

# MMC 16 KEY EXTENDER

**Description:**

Used to view the programmable keys assigned to a keyset station. In addition, it allows the system administrator to assign key extenders to some keys that will make a general access feature key more specific. The feature keys that can have extenders are listed below.

FEATURE KEY	EXTENDER
<b>FWE</b>	External Call Forward(00~99)
<b>SPD</b>	Dial(00~99)
<b>VAC</b>	Vacant messages(01~20)
<b>PAG</b>	Page(0~5,*)
<b>DOR</b>	Door & Door Lock control (1~4)
<b>EXC</b>	Boss and Secretary(1~2)
<b>DPC</b>	Direct Pickup(station/trunk-line number)
<b>GPC</b>	Group Pickup(0~9)

**Action**

**Display**

1. Press **AUTO RDL** and dial **16**

201 01:701:

2. Using **LINE1** or **LINE2**, select the station you want (e.g. 202)

202 01:701

3. Press **RDL** or **CONF** to select the button (e.g. 22)

202 22:PAG1

OR

Press the button you want to program extender (if the button is programmed).

4. Select the extender according to the table above. Previous extenders will be overwritten

202: 22:PAG2

If you want to clear the previous extender, press **HOLD**

5. Press **AUTO RDL** to save and exit

***DEFAULT DATA***

EACH KEY EXTENDER IS EQUAL TO STATION KEY PROGRAMMING  
(MMC 72) DATA

***RELATED MMC***

MMC 71 SYSTEM KEY PROGRAMMING  
MMC 72 STATION KEY PROGRAMMING



**MMC 20****OPEN PROGRAMMING****Description:**

Used to open (enable) or close (disable) customer- or technician-level programming. If programming is not opened and an attempt is made to access a system MMC, the error message [ACCESS DENIED] will be displayed. A 4-digit customer passcode is required to access customer-level programming allowed in MMC 90 (Customer Use MMC). A 4-digit technician's passcode is required to open all MMCs.

**Action**

1. Press **AUTO RDL** and dial **20**
2. Enter passcode  
Default passcodes are 1234 for customer-level Programming and 4321 for technician-level programming
3. Press **MUTE/DND** or **MSG** to select **DISABLE** or **ENABLE**  
OR  
Dial **0** for **DISABLE**  
or **1** for **ENABLE**  
(e.g. 1)
4. Press **AUTO RDL** to save and exit

**Display**

PASSCODE:

PASSCODE:\*\*\*\*

ENABLE

**DEFAULT DATA**

DISABLE

**RELATED MMC**

CUSTOMER PROGRAMMING : Refer to MMC 90

TECHNICIAN LEVEL PROGRAMMING : ALL MMCs

# MMC 21 CHANGE PASSCODE

**Description:**  
 Used to change the passcode allowing access to MMC 20 (Open Programming) from its current value.

**NOTE:**  
 ;<sup>⌘</sup> The passcode is four digits long. Each digit can be 0-9. The current (old) passcode is required for this MMC.  
 ;<sup>⌘</sup> Allows the technician to reset the customer passcode to default value '1234' by pressing HOLD button.

**Action**

**Display**

1. Press **AUTO RDL** and dial **21**

NEW CODE:

2. Enter new passcode via keypad (max four digits)  
 To change customer passcode, first enable customer Programming  
 To change technician passcode, first enable technician Programming

NEW CODE:\*\*\*\*

Display shows

REENTER:

3. Reenter new passcode via KEYPAD

REENTER:\*\*\*\*

If re-entered passcode is correct, display will show 'SUCCESS'

SUCCESS

OR

If it is incorrect, display will show 'ERROR' is

ERROR

4. Press **AUTO RDL** to save and exit

**DEFAULT DATA**

CUSTOMER PASSCODE: 1234

TECHNICIAN PASSCODE: 4321

**RELATED MMC**

MMC 20 OPEN PROGRAMMING

# MMC 22 CUSTOMER ON/OFF

**Description:**  
 Used to allow the system administrator to set the following keyset features:

BGM	When ON, allows the user to hear background music.
DND	When ON, allows the user to set the Do Not Disturb feature.
DOOR	When ON, allows the user to open the door.
HUNT	When ON, the intercom call will be forwarded to the next station of the station group to which the station belongs.
MIKE	When ON, the station can activate the speakerphone call.
PAGE USE	When ON, the station can page.
PAGE RECEIVE	When ON, the station can receive paging announcements.
SMDR	When OFF, the information related to the station will not be printed on the SMDR report.

**Action**

**Display**

1. Press **AUTO RDL** and dial **22**

201: BGM: ON

2. Using **LINE1** or **LINE2**, select the station you want  
(e.g. 202)

202: BGM: ON

If you want to select all stations, press **LINE1**

3. Press **RDL** or **CONF** to select the keyset feature  
(described above, e.g. DND)

202: DND: ON

4. Press **MUTE/DND** or **MSG** to select data  
 OR  
 Using the KEYPAD, dial  
**0 for OFF**  
 or **1 for ON**

202: DND: OFF

5. Press **AUTO RDL** to save and exit

**DEFAULT DATA**

BGM : ON  
DND : ON  
DOOR : ON  
HUNT : OFF  
MIKE : ON  
PAGE USE : ON  
PAGE RECEIVE : ON  
SMDR : ON

**RELATED MMC**

HUNT : MMC 35 ASSIGN STATION GROUP  
PAGE USE, PAGE RECEIVE : MMC 23 PAGE ZONE  
SMDR : MMC 81 SMDR OPTION

**MMC 23****PAGE ZONE****Description:**

Used to assign a keyset to any of the four internal paging zones and no zone.

NOTE : Number 5 makes all external paging, number 0 makes all internal paging and \* makes all internal and external paging.

**Action****Display**

1. Press **AUTO RDL** and dial **23**

201: NO ZONE

2. Using **LINE1** or **LINE2**, select the station you want(e.g. 202)

202: NO ZONE

If you want to select all stations, press **LINE1**

3. Pressing **MUTE/DND** or **MSG** to make selection  
OR

202: ZONE1

Using KEYPAD, dial

**0** for **NO ZONE**

**1** for **ZONE 1**

**2** for **ZONE 2**

**3** for **ZONE 3**

or **4** for **ZONE 4** (e.g. ZONE 1)

4. Press **AUTO RDL** to save and exit

**DEFAULT DATA**

NO ZONE

**RELATED MMC**

MMC 22 CUSTOMER ON/OFF (PAGE USE / PAGE RECEIVE)

# MMC 24 ASSIGN BARGE-IN

This MMC is used to set the type of barge-in permitted at a particular station. After the barge-in type is set, the barge-in class can be set. The barge-in class allows or disallows the user to barge-in on another station.

OPTION	BARGE-IN TYPE	DESCRIPTION
0	NO BARGE-IN	Barge-in feature is unavailable regardless of a station's barge-in status.
1	WITH TONE	Barge-in will produce an intrusion tone and display at the barged-in on station.
2	WITHOUT TONE	Barge-in is allowed. There is no barge-in tone and no display at the barged-in station, and the barge-in station will be muted.

OPTION	BARGE-IN CLASS	DESCRIPTION
00	NN	You cannot barge-in. / Nobody can barge-in on you.
01	NY	You cannot barge-in. / Others can barge-in on you.
10	YN	You can barge-in. / Nobody can barge-in on you.
11	YY	You can barge-in. / Others can barge-in on you.

**PROCEDURE**

1. Press **AUTO RDL** and dial **24**
  
2. Pressing **MUTE/DND** or **MSG** to select barge-in type  
 OR  
 Using KEYPAD, dial  
     **0** for **NO BARGE IN**  
     **1** for **WITH TONE**  
     or **2** for **WITHOUT TONE**
  
3. Using **LINE1** or **LINE2**, select a station (e.g. 202)  
*To select all stations, press **LINE1** first*

**DISPLAY**

NO BARGE IN

WITH TONE

202: NN

## MMC 24

4. Using KEYPAD, dial

**00 for NN**

**01 for NY**

**10 for YN**

or **11 for YY**

You can select barge-in class  
(NN, NY, YN, YY)

202: YN

5. Press **AUTO RDL** to save and exit

**DEFAULT DATA**

BARGE-IN TYPE : NO BARGE IN  
BARGE-IN CLASS : NN

**RELATED MMC**

NONE

# MMC 25 HOT/WARM LINE

**Description:**  
 Used to assign a hot line/warm line destination for each station. The destination may be one of the following:

- Station Number**
- Station Group Number**
- Trunk Number**
- Trunk Group Number**
- 16 plus Speed Dial Number(00~99)** (16 is SPD ID number described in MMC 70)

The Warm Line Delay Time also can be assigned by this MMC.

<i><b>Action</b></i>	<i><b>Display</b></i>
1. Press <b>AUTO RDL</b> and dial <b>25</b>	201: : 0SEC
2. Using KEYPAD, select the destination(e.g. 233)	201: 233: 0SEC
3. Enter the Warm Line Delay Time (0 - 9 sec) (e.g. 5)	201: 233: 5SEC
4. Press <b>AUTO RDL</b> to save and exit	

**DEFAULT DATA**

DESTINATION : NONE  
 WARM LINE DELAY TIME: 0 SEC

**RELATED MMC**

NONE

**MMC 26****ALARM REMINDER****Description:**

Used to allow the system administrator or technician to set or change the alarm clock/appointment reminder feature for any station. Three alarms may be set for each station and each alarm may be defined as a DAY alarm or as a DAILY alarm. The DAY alarm is automatically cancelled after it rings, while the DAILY alarm rings every day at the same time.

**Action****Display**

1. Press **AUTO RDL** and dial **26**

201 A1:HHMM:DAY

Using **LINE1** or **LINE2**, select the station you want(e.g. 202)

202 A1:HHMM:DAY

2. Press **RDL** or **CONF** to select the alarm number (1~3)(e.g. 2)

202 A2:HHMM:DAY

3. Dial the alarm time. The time is entered in 24-hour format (e.g. 2030 is 8:30 p.m.)  
To clear alarm data, press **HOLD**

202 A2:2030:DAY

4. Press **MUTE/DND** or **MSG** to select alarm mode (e.g. DAILY)

202 A2:2030:DALY

5. Press **AUTO RDL** to save and exit

**DEFAULT DATA**

ALARM1 : HHMM    DAY  
ALARM2 : HHMM    DAY  
ALARM3 : HHMM    DAY

**RELATED MMC**

MMC 55    CURRENT DATE AND TIME

# MMC 27 VACANT MESSAGE

**Description:**

The system provides up to 20 vacant messages that can be selected by any display keyset user. Of these, 10 messages (01-10) are pre-programmed and the other 10 messages (11-20) can be customised using this MMC. Once activated, the selected message will appear in the display of the calling station.

NO.	MESSAGE
01	IN A MEETING
02	OUT ON A CALL
03	OUT TO LUNCH
04	LEAVE A MESSAGE
05	PAGE ME
06	OUT OF TOWN
07	IN TOMORROW
08	RETURN AFTERNOON
09	ON VACATION
10	GONE HOME

**Action**

**Display**

1. Press **AUTO RDL** and dial **27**

MSG11:

2. Using **LINE1** or **LINE2**, select the desired message number (11-20) (e.g. 12)

MSG12:

3. Enter the vacant message (refer to MMC 14 for details of letter entry procedure)

BUSINESS TRIP

4. Press **AUTO RDL** to save and exit

**DEFAULT DATA**

NONE

**RELATED MMC**

NONE

**MMC 28** **CALL DISC**

**Description:**  
 Used to assign the incoming and outgoing status of a selected station. There are four different options.

0	No Discrimination
1	Out Only
2	In Only
3	Both

**Action**

**Display**

1. Press **AUTO RDL** and dial **28**

201: NO DISC

2. Using **LINE1** or **LINE2**, select the station you want (e.g. 202)

201: NO DISC

If you want to select all stations, press **LINE1**

3. Press **MUTE/DND** or **MSG** key to select discrimination type as above

202: BOTH

4. Press **AUTO RDL** to save and exit

**DEFAULT DATA**

NO DISC

**RELATED MMC**

- MMC 42 TRUNK ON/OFF
- MMC 50 SYSTEM TMERS
- MMC 46 ASSIGN DISA LINE



# MMC 31 EXT/TRK USE

**Description:**

Used to allow trunks on a per-station basis the ability to answer incoming calls, to dial out or to do both. These abilities are displayed as Y or N for each action (e.g. NY means disallow dialling out but allow answering of incoming calls).

DIAL DIGIT	TRK USE	DESCRIPTION
00	NN	You cannot either dial and answer
01	NY	You cannot dial but can answer
10	YN	You can dial but cannot answer
11	YY	You can both dial and answer

**Action**

**Display**

1. Press **AUTO RDL** and dial **31**

201: USE 701 :YY

2. Using **LINE1** or **LINE2**, Select the station you want (e.g. 202)

202: USE 701 :YY

If you want to select all stations, press **LINE1**

3. Select the trunk number by pressing **RDL** or **CONF** (e.g. 702)

202: USE 702 :YY

If you want to select all trunks, press **RDL**

4. Using keypad, dial  
**0 (N) to deny action**  
**or 1 (Y) to allow action**

202: USE 702 :NY

(Two digits must be dialled: first digit for dialling out and second for answering incoming calls, e.g. 01)

5. Press **AUTO RDL** to save and exit

**DEFAULT DATA**

ALL TRUNK: YY

**RELATED MMC**

NONE

# MMC 32 INTERCOM USE

**Description:**  
Used to allow/disallow station intercom calls.

**Action**

**Display**

1. Press **AUTO RDL** and dial **32**

201: CALL 202:Y

2. Using **LINE1** or **LINE2**, select the station you want (e.g. 202)

202: CALL 201:Y

If you want to select all stations, press **LINE1**

3. Press **RDL** or **CONF** to select call station (e.g. ALL)

202: CALL ALL:?

If you want to select all stations, press **RDL**

4. Pressing **MUTE/DND** or **MSG** to select allow/disallow option(e.g. disallow all intercom calls)  
OR

202: CALL ALL:N

Using KEYPAD, dial

**0(N) for disallow intercom calls**  
**1(Y) for allow intercom calls**

If you select N, intercom calls are not possible but calling the operator is possible

5. Press **AUTO RDL** to save and exit.

**DEFAULT DATA**

CALL ALL : Y

**RELATED MMC**

NONE

**MMC 33****ASSIGN DOOR RING****Description:**

Used to designate which devices (station or station group) will ring when a door box button is pressed.

**Action**

1. Press **AUTO RDL** and dial **33**  
Display shows designated stations or station groups for DOOR1(day and night)
2. Press **LINE1** or **LINE2** to select DOOR 1 or DOOR 2 (e.g. DOOR 2)
3. Enter new DAY/NIGHT selection via keypad (e.g. 501 for day, and 201 for night)
4. Press **AUTO RDL** to save and exit

**Display**

DOR1 D:500 N:500

DOR2 D:500 N:500

DOR2 D:501 N:201

**DEFAULT DATA**

DOOR1 : DAY:500 NIGHT:500  
DOOR2 : DAY:500 NIGHT:500

**RELATED MMC**

MMC 35 ASSIGN STATION GROUP

**MMC 34****ASSIGN PICKUP GROUP****Description:**

Used to allow the assignment of stations into call pickup groups. There is a maximum of 10 pickup groups (0-9). An unlimited number of members can belong to each group. Stations can be in only one pickup group at any given time.

**Action****Display**

1. Press **AUTO RDL** and dial **34**

[GPC0] 01:220

Display shows the first member of pickup group 0

2. Using **LINE1** or **LINE2**, select the pickup group number (e.g. GPC1)

[GPC1] 01:

3. Dial station number (e.g. 203)

[GPC1] 01:203

If dialled number is a member of another pickup group,  
the station number will be removed from the  
previous group automatically

The Dialled number overwrites any previous number

Press **HOLD** to clear previous entries

4. Press **AUTO RDL** to save and exit

**DEFAULT DATA**

[GPC0] : All stations  
[GPC1]<sub>i</sub>-[GPC9] : NONE

**RELATED MMC**

NONE

# MMC 35                      ASSIGN STATION GROUP

**Description:**

Used to assign members of a station group. There are several options that can be selected for ringing, overflow, group transfer and overflow destination, group types. There is a maximum of twenty (20) station groups.

OPTIONS	DISPLAY	RANGE
Ring mode	RING	
Overflow time	OVER	000 j- 250 sec
Group transfer time	TRSF	000 j- 250 sec
Overflow port	NEXT	
Group types	TYPE	

RING MODES	DESCRIPTION
1 SEQUENTIAL	The first idle station listed in the group will ring. If the first is busy, the next idle station will ring.
2 DISTRIBUTE	The first call will ring the first station listed in the group. The next call will ring the next station listed in the group.
3 CONDITION	All the non busy stations listed in the group will ring.
4 UNCONDITION	All the stations listed in the group will ring. Busy stations will receive off-hook ring.

**GROUP TYPES**

- 1    NORMAL GROUP
- 2    VMAA GROUP

**Action**

1. Press **AUTO RDL** and dial **35**  
  
Display shows ring mode of group 500 (operator group)
  
2. Using **LINE1** or **LINE2**, select the station group number(500 j-519).

**Display**

500: RING :DIST

501: RING: DIST

**MMC 35**

- 3. Pressing **RDL** or **CONF**, select the options(RING, OVER,TRSF,NEXT,TYPE or MEMBER)  
Go to 4a - 4f depending on selection

500: OVER: 030S
- 4a. To select RING mode, press **MUTE/DND** or **MSG**  
OR  
Dial  
    1 for SEQUENTIAL  
    2 for DISTRIBUTE

500: RING: UNCO
- 4b. To change the OVERFLOW TIME, dial 3 digits

500: OVER: 030S
- 4c To change the GROUP TRSF TIME, dial 3 digits

500: TRSF: 045S
- 4d To assign the overflow port (NEXT), enter the station or station group number (e.g. 501)

500: NEXT: 501
- 4e Press **MUTE/DND** or **MSG** to select the station group TYPE (e.g. NORMAL)  
OR  
Using keypad, dial  
    1 for NORMAL GROUP  
    2 for VMAA GROUP

500: TYPE:NORMAL
- 4f To assign MEMBER of a station group, enter the station number (e.g. 201)

500: MEM1:201
- 5. Press **AUTO RDL** to save and exit

**DEFAULT DATA**

RING	:	DIST	
OVERFLOW	:	030 SEC	
TRANSFER TIME	:	045 SEC	
TYPE	:	NORMAL GROUP	
MEMBER	:	500 GROUP	: 201
		OTHER GROUP	: NONE

**RELATED MMC**

MMC 22 CUSTOMER ON/OFF

# MMC 36                      ASSIGN BOSS/SECRETARY

**Description:**  
 Used to assign BOSS keysets to SECRETARY keysets. One SECRETARY station may have up to two (2) BOSS stations.

**Action**

**Display**

1. Press **AUTO RDL** and dial **36**

S201 1:    2:

2. Using **LINE1** or **LINE2**, select the SECRETARY station you want(e.g. 202)  
 Display shows the BOSS stations

S202 1:    2:

3. Enter the BOSS stations  
 (e.g. BOSS1: 220, BOSS2: 230)

S202 1:220 2:230

4. Press **AUTO RDL** to save and exit

**DEFAULT DATA**

BOSS1:NONE    BOSS2:NONE

**RELATED MMC**

NONE

# MMC 37                      ASSIGN ADD-ON MODULE

**Description:**  
Used to designate to which station an add-on module (AOM) is assigned.

**Action**

**Display**

1. Press **AUTO RDL** and dial **37**  
Display shows the first AOM port

205: MASTER:

If there is no AOM port, display shows

AOM NOT EXIST

2. Press **LINE1** or **LINE2**, select the AOM port (e.g. 206)

206: MASTER:

If you want to clear the previous entry, press **HOLD**

3. Enter master station number (e.g. 204)

206: MASTER:204

4. Press **AUTO RDL** to save and exit

**DEFAULT DATA**

NONE

**RELATED MMC**

NONE

# MMC 38

# SLT DIALLING TYPE

**Description:**

Used to define the type of phone connected to each SLT port for dialling purposes. Keysets are not affected by this MMC. There are two dialling types.

**DIALLING TYPES**

- |   |       |                                |
|---|-------|--------------------------------|
| 1 | DTMF  | Dual Tone Multi Frequency type |
| 2 | PULSE | Dial Pulse type                |

**Action**

1. Press **AUTO RDL** and dial **38**  
Display shows the SLT port(e.g. 217)
  
- If there is no SLT port, display shows
  
2. Using **LINE1** or **LINE2**, select the SLT port number (e.g. 218)
  
3. Press **MUTE/DND** or **MSG** to select the SLT type.  
 OR  
 Using KEYPAD, dial  
     **1 for DTMF**  
     or **2 for PULSE**
  
4. Press **AUTO RDL** to save and exit

**Display**

217: DTMF

SLT NOT EXIST

218: DTMF

218: PULSE

**DEFAULT DATA**

DTMF

**RELATED MMC**

NONE

**MMC 39 DATA LINE**

**Description:**  
 Used to assign SLT ports that will be used for data transmission.

**VOICE** The station will be used for voice communication. All intrusion and warning tones will be heard during conversation.

**DATA** The station will be used for data communication. No intrusion and warning tones will interfere with data transmission

**Action**

**Display**

- 1. Press **AUTO RDL** and dial **39**  
 Display shows (e.g. 209 is SLT port)

209: VOICE

- 2. Using **LINE1** or **LINE2**, select the SLT port number (e.g. 210)

210: VOICE

If you want to select all SLT ports, press **LINE1**

- 3. Press **MUTE/DND** or **MSG** to select VOICE or DATA  
 (the port connected to a peripheral device, such as Fax, is set to DATA line)  
 OR  
 Dial  
     **1 for VOICE**  
     or **2 for DATA**  
 (e.g. 2)

210: DATA

- 4. Press **AUTO RDL** to save and exit

**DEFAULT DATA**

VOICE LINE

**RELATED MMC**

NONE

# MMC 40 C.O. PBX LINE

**Description:**  
 Used to select the mode of the C.O. line. If PBX mode is chosen, the PBX access code can be recognised, allowing more complete toll restriction. This mode is assigned on a per-trunk basis.

**Action**

**Display**

1. Press **AUTO RDL** and dial **40**

701: C.O

2. Using **LINE1** or **LINE2**, select the trunk number you want(e.g. 702)

702: C.O

If you want select all trunk lines, press **LINE1**

3. Press **MUTE/DND** or **MSG** to set the trunk C.O. or PBX line  
 OR  
 Using KEYPAD, dial  
     **1 for C.O line**  
     or **2 for PBX line**(e.g. PBX line)

702: PBX

4. Press **AUTO RDL** to save and exit

**DEFAULT DATA**

C.O LINE

**RELATED MMC**

NONE

**MMC 41****TRUNK DIALLING TYPE****Description:**

Used to determine the dialling type of each C.O. line. There are two options: Dual Tone Multi Frequency (DTMF) and Dial Pulse (PULSE).

**Action****Display**

1. Press **AUTO RDL** and dial **41**

701: DTMF

2. Using **LINE1** or **LINE2**, select the trunk number you want (e.g. 702)

702: DTMF

If you want to select all trunks, press **LINE1**

3. Press **MUTE/DND** or **MSG** to select the trunk dial type

702: PULSE

OR

Using **KEYPAD**, dial

**1** for **DTMF**

or **2** for **PULSE**

(e.g. PULSE)

4. Press **AUTO RDL** to save and exit

**DEFAULT DATA**

DTMF

**RELATED MMC**

MMC 53 TRUNK-WIDE TIMERS

MMC 54 MAKE/BREAK RATIO

# MMC 42 TRUNK ON/OFF

**Description:**

Used to assign several options on a per-trunk basis:

OPTIONS	DESCRIPTION
1A2 EMULATION	Trunk override call
TRUNK FORWARD	Allows trunk to be forwarded (Refer to APPENDIX D)
RING OVER PAGE	Allows ring over external page
TOLL CHECK FREE	C.O. lines to follow or bypass toll restriction
VOICE MSG	Voice announcement of DISA line
TRK DISC	Enable Trunk disconnection

**Action**

**Display**

1. Press **AUTO RDL** and dial **42**

701:1A2 EMUL:OFF

2. Using **LINE1** or **LINE2**, select trunk number you want (e.g. 702)

702:1A2 EMUL: OFF

3. Using **RDL** or **CONF**, select the option you want (as described above, e.g. RING OVER PAGE)

702:PAGE RING:OFF

4. Press **MUTE/DND** or **MSG** to select ON or OFF.  
 OR  
 Using **KEYPAD**, dial  
**0 for OFF**  
 or **1 for ON**

702:PAGE RING:ON

5. Press **AUTO RDL** to save and exit

**DEFAULT DATA**

1A2 EMULATION : OFF  
 TRUNK FORWARD : OFF  
 RING OVER PAGE : OFF  
 TOLL CHECK FREE : OFF  
 VOICE MSG : OFF  
 TRK DISC : OFF

**RELATED MMC**

TRUNK FORWARD : MMC 11 CALL FORWARD  
 VOICE MSG : MMC 46 ASSIGN DISA LINE  
 TRK DISC : MMC 28 CALL DISC  
 MMC 50 STSYEM TIMERS

**MMC 43****ASSIGN TRUNK RING****Description:**

Used to enable ringing to a specific station or to a group of stations when incoming calls are received. This MMC controls both day and night locations.

**Action**

1. Press **AUTO RDL** and dial **43**
2. Using **LINE1** or **LINE2**, select the trunk you want (e.g. 702)  
  
If you want to select all trunks, press **LINE1**
3. Dial the station or station group number that will be ringing (e.g. 500 for Day, 201 for Night)
4. Press **AUTO RDL** to save and exit

**Display**

701	D:500	N:500
-----	-------	-------

702	D:500	N:500
-----	-------	-------

702	D:500	N:201
-----	-------	-------

**DEFAULT DATA**

ALL TRUNKS    DAY:500    NIGHT:500

**RELATED MMC**

MMC 35    ASSIGN STATION GROUP  
MMC 56    ASSIGN AUTO NIGHT TIME

# MMC 44 TRUNK NAME

**Description:**

Used to allow a 12-character name to identify an individual trunk. Names are written using the keypad. Each press of a key will select a character. For example, to select 'A' press key number 2 once (twice for 'B' and so on). Press the desired key to move the cursor to the next position.

dial count	1	2	3	4	5	6	7	8	9	0	*	#
1	█	A	D	G	J	M	P	T	W	:	?	
2	1	B	E	H	K	N	Q	U	X	.	&	[
3		C	F	I	L	O	R	V	Y	!	\$	]
4		2	3	4	5	6	S	8	Z	0	*	#
5							7		9			

NOTE : When the character you want appears on the same dial pad key as the previous character, press CONF to move the cursor to the right. A space can be entered using these keys.

**Action**

1. Press **AUTO RDL** and dial **44**
2. Press **LINE1** or **LINE2** to select the trunk you want (e.g. 702)
3. Enter the trunk name using above table (e.g. SEOUL LINE)
4. Press **AUTO RDL** to save and exit

**Display**

701:NX828

702:

702: SEOUL LINE

**DEFAULT DATA**

NX-828

**RELATED MMC**

NONE

# MMC 45 TRUNK GROUP

**Description:**

Used to set free trunk selection type and to allow assignment to a specific trunk group or to several trunk groups. There are eleven (11) trunk groups, 9 and 80-89, and three modes of selecting free trunk line in the group.

MODE	DESCRIPTION
<b>DISTRIBUTE</b>	Searches the trunk group in circular order. Each time the group is accessed, the next available trunk in the group is selected.
<b>HIGH TO LOW</b>	Searches the trunk group from last trunk to the first trunk in the group. If the trunk is busy, the previous available trunk in the group is selected.
<b>LOW TO HIGH</b>	Searches the trunk group. If the first trunk in the group is busy, the next one is selected

**Action**

**Display**

1. Press **AUTO RDL** and dial **45**  
Display shows the free trunk selection mode
2. Press **MUTE/DND** or **MSG** to select the free trunk selection mode  
OR  
Using KEYPAD, dial  
    **1 for DISTRIBUTE**  
    **2 for High to Low**  
    or **3 for Low to High.**  
    (e.g. 2)
3. Using **LINE1** or **LINE2**, to select the trunk group (e.g. GRP80)
4. Press **RDL** or **CONF** to scroll the members of the group (e.g. 02)
5. Enter a valid trunk number (e.g. 709)
6. Press **AUTO RDL** to save and exit

MODE: DISTRIBUTE

MODE: HIGH TO LOW

GRP80 01:

GRP80 02:

GRP80 02:709

***DEFAULT DATA***

GROUP 9 : ALL TRUNK LINES  
GROUP 80~89 : NONE

***RELATED MMC***

NONE

# MMC 46 ASSIGN DISA LINE

**Description:**

This MMC is used to allow the system the ability to have Direct Inward System Access (DISA). There are four 4 DISA. If a trunk is set to DISA, the voice announcement feature may be used when the VOICE MSG option is enabled in MMC 42 TRUNK ON/OFF.

OPTIONS	DESCRIPTION
0 NO DISA LINE	No DISA service
1 DISA IN NIGHT MODE	In night mode, DISA is available
2 DISA IN DAY MODE	In day mode, DISA is available
3 DISA BOTH NIGHT AND DAY	In day and night mode, DISA is available

**Action**

**Display**

1. Press **AUTO RDL** and dial **46**  
Display shows

701: NO DISA

2. Using **LINE** or **LINE2** select the trunk you want (e.g. 702)

702: NO DISA

If you want select all trunks, press LINE1

3. Press **MUTE/DND** or **MSG** to select  
OR  
Using KEYPAD, dial  
**0** for **NO DISA LINE**  
**1** for **DISA IN NIGHT MODE**  
**2** for **DISA IN DAY MODE**  
**3** for **DISA BOTH NIGHT AND DAY**  
(e.g. 1)

702: NIGHT DISA

4. Press **AUTO RDL** to save and exit

**DEFAULT DATA**

NO DISA

**RELATED MMC**

- MMC 28 CALL DISK
- MMC 42 TRUNK ON/OFF
- MMC 50 SYSTEM TIMERS

# MMC 47 ASSIGN MPD

**Description:**

Used to allow the trunk to check the Metering Pulse. If you set the MPD option to 'ON' the system must have an MPD card.

OPTIONS	DESCRIPTION
0 NO MPD	No service
1 MPD ON	MPD is available

**Action**

**Display**

1. Press **AUTO RDL** and dial **47**

701: NO MPD

2. Press **LINE1** or **LINE2**, to select the trunk you want(e.g. 702)

702: NO MPD

If you want to select all trunks, press **LINE1**

3. Press **MUTE/DND** or **MSG** to make selection  
OR  
Using KEYPAD, dial  
**0 for NO MPD**  
or **1 for MPD ON**  
(e.g. 1)

702: MPD ON

4. Press **AUTO RDL** to save and exit

**DEFAULT DATA**

NO MPD

**RELATED MMC**

MMC 57 CALL COST

# MMC 50 SYSTEM TIMERS

**Description:**  
 Used to adjust individual timers as necessary. All available timers are described in the Table of Timers and Values, below.

NOTE: Display shows second as S, millisecond as MS, and minute as MI.

**Action**

**Display**

1. Press **AUTO RDL** and dial **50**

ALM R INT :025SEC

2. Press **LINE1** or **LINE2** to select timer (e.g. ALM R DUR)

ALM R DUR: 010SEC

3. Enter new value using KEYPAD(e.g. 005)

ALM R DUR: 005SEC

4. Press **AUTO RDL** to save and exit

**DEFAULT DATA**

See TABLE OF TIMERS AND VALUES

**RELATED MMC**

NONE

**TABLE OF TIMERS AND VALUES**

DISPLAY	DESCRIPTION	DEFAULT	RANGE
ALM R INT (Alarm ring interval)	Controls the time between ring attempts at a station when alarm reminder is set.	025S	1-250S
ALM R DUR (Alarm ring duration)	Controls the length of ring cycle duration when alarm reminder is set at a station.	010S	1-250S
ARDL INT (Auto Redial interval)	Controls the time between attempts after Auto Redial is set on a station.	045S	1-250S
ARDL RELS (Auto Redial release time)	Controls the duration of a Ring No Answer condition on an auto redial number dialled before auto redial is automatically cancelled.	045S	1-250MI
CBACK NOA (Callback no answer time)	Controls the time before the callback is automatically cancelled when a callback detects Ring No Answer.	030S	100-2500MS
CO CO DIS (CO to CO disconnect time)	Monitors the duration of an unsupervised conference, external call; forward or DISA call upon expiring, both trunks are disconnected.	010MI	1-250S
DISA FDG	First digit want time in DISA call	025S	1-250S
DISA IDG	Inter digit duration in DISA call	025S	1-250S
DISA RING	Controls the duration of ringing at the DISA called station before automatically transferred to the operator group.	030s	1-250S
DOOR RELS (Door release time)	Controls the duration of time before the door lock relay is activated.	1500MS	100-2500MS
DOR R OFF (Door Ring OFF duration)	Controls the duration of ringing at the door ring destination before automatically cancelling.	030S	1-250S

**MMC 50**

<b>DISPLAY</b>	<b>DESCRIPTION</b>	<b>DEFAULT</b>	<b>RANGE</b>
<b>FIRST DGT</b> (First Digit wait time)	Controls how long the system will wait for dialling to begin before dropping the dial tone and returning the user to error tone.	025S	1-250S
<b>HOOK OFF</b> (Hook OFF time)	Controls the time before dial tone is sent to a single line station.	0200MS	100-2500MS
<b>INTER DGT</b> (Inter Digit duration)	Controls the grace period between dialling valid digits and dropping the call and returning the user to error tone.	025S	1-250S
<b>MMC OUT</b> (MMC session time)	Controls the grace period between programming actions while in programming session, and automatically returns system to secure programming status.	030S	10-250S
<b>OFF R INT</b> (Off hook Ring Interval)	Controls the time between ring bursts to a user who has a camped-on call.	015S	1-250S
<b>PAGE MAX</b> (Page duration)	Controls the duration of a page announcement.	020S	1-250S
<b>RCAL DISC</b> (Recall Disconnect time)	This is the time an attendant recall will ring before being disconnected.	002MI	1-250MI
<b>RCAL RING</b> (Recall Ring length)	This is the length of time a transfer recall will ring at a station before recalling the operator.	015S	0-250S
<b>RCAL WAIT</b> (Recall Waiting time)	If a transferred call is recalled at the transferring station and the station is busy, this timer will expire and transfer the call to the operator. This only applies to trunk calls.	015S	0-250S
<b>RCAL HOLD</b> (Recall Hold time)	Determines the time calls can be left on hold before recalling back to the holding station.	045S	0-250S
<b>RCAL TRSF</b> (Recall Transfer time)	Determines the time that transferred calls ring before recalling.	045S	0-250S
<b>SLT F MIN</b> (minimum SLT flash time)	Monitors the duration of a hookswitch flash to ensure that the flash is valid and not a line noise or an accidental hookswitch bounce. It is the minimum time for a single line station.	0100MS	10-2500MS
<b>SLT F MAX</b> (maximum SLT flash time)	Maximum time of hookswitch flash of single line station.	0400MS	10-2500MS
<b>SMDR PULS</b> (SMDR start time for rotary dialing)	this grace period timer starts SMDR recording for pulse (rotary) dialing and controls the LCD duration timer on the keysets.	030S	1~250S
<b>SMDR DTMF</b> (SMDR start time for touchtone dialing)	this grace period timers starts SMDR recording for DTMF (Touch Tone) dialing and controls the LCD duration timer on the keysets.	015S	1~250S
<b>TRK DISC</b>	controls the duration of an outside call	030MIN	1~250S

# MMC 51 TONE/RING CADENCE

**Description:**  
 Provides the ability to customise the tone cadence on a system-wide basis. There are eight (8) tone cadences available. **Please call Technical Support before changing any cadences as some systems may require default settings.**

**Action**

**Display**

1. Press **AUTO RDL** and dial **51**

DT: CONTINUOUS

2. Press **LINE1** or **LINE2** to select the tone you want

RBT: 100200100200

Press **MUTE/DND** or **MSG** to select dial tone control (continuous tone or interrupt tone) (e.g. interrupt tone)

DT: 100025100025

Default data of interrupt tone is 1000 0250  
 1000 0250 msec

3. Dial new interrupt time value, ON/OFF/ON/OFF in intervals of 50 msec. Each value is 3 digits and Represents a unit of 10 msec: e.g. 100/030/100/03  
 0 is 1000 msec (100x10) for ON and 300 msec (030x10) for OFF

RBT: 100030100030

4. Press **AUTO RDL** to save and exit

**DEFAULT DATA**

TONE NAME	DISPLAY	DATA
DIAL TONE	(DT)	CONTINUOUS TONE CHECK
RING BACK TONE	(RBT)	1000 2000 1000 2000 MSEC
BUSY TONE	(BST)	0500 0500 0500 0500 MSEC
TRSF TONE	(TT)	0200 0200 0200 0200 MSEC
ERROR TONE	(ERT)	0500 0250 0500 0250 MSEC
CO LINE RING	(COR)	1000 3000 1000 3000 MSEC
STATION RING	(STR)	0400 0200 0400 3000 MSEC

**RELATED MMC**

NONE

# MMC 52 SYSTEM-WIDE COUNTER

**Description:**

Used to set the values of the system counters described below.

**ALM COUNTER**  
(ALARM REMINDER COUNTER)

The number of times that an alarm reminder will ring a station before cancelling (range: 1-99).

**ARDL COUNTER**  
(AUTO REDIAL COUNTER)

The number of times the system will redial an outside number after the auto redial feature has been activated.

**Action**

**Display**

1. Press **AUTO RDL** and dial **52**

ALM COUNTER: 03

2. Press **LINE1** or **LINE2** to select the counter you want (e.g. ARDL)

ARDL COUNTER: 10

3. Dial new data (two digit e.g. 05)

ARDL COUNTER: 05

4. Press **AUTO RDL** to save and exit

**DEFAULT DATA**

ALM COUNTER : 3  
ARDL COUNTER : 10

**RELATED MMC**

NONE

# MMC 53 TRUNK-WIDE TIMERS

**Description:**

Allows trunk timer values to be changed for all trunks. **It is not advisable to change these values, with the exception of trunk flash time, without assistance from Technical Support.**

Ten (10) options are available and are listed below.

DISPLAY	DESCRIPTION	RANGE
<b>CLEARING</b> (clearing time)	The interval after disconnecting the call and reusing the trunk line.	0~25sec
<b>CO SUPV</b> (CO supervision time)	The interval of checking the C.O.	000~9000 msec
<b>F DGT DLY</b> (first digit delay time)	After seizing the trunk line, system sends the first digit.	100~2500 msec
<b>FLASH PBX</b> (PBX flash time)	The duration of a flash when connected to a C.O.	100~2500 msec
<b>MFS ON TM</b> (MF sender on time)	The duration of DTMF Sender ON status when sending DTMF signal	100~2500 msec
<b>MF OFF TM</b> (MF sender off time)	The duration of DTMF Sender OFF when sending DTMF signal.	100~2500 msec
<b>MPD DETCT</b> (MPD detect time)	The minimum duration of MPD signal when the signal is incoming.	40~500 msec
<b>NEW CALL</b> (New Call time)	The duration of a flash sent to the central office to disconnect the line.	100~2500 msec
<b>NO RING</b> (no ring time)	After the incoming outside call is detected, if the outside call is disconnected without call processing, the system checks none of ring signal on the C.O line and release the C.O line.	1-25sec
<b>PAUSE TM</b> (pause time)	This is a pause duration timer. A pause is an instruction for the system to wait.	1~25sec
<b>RNG DETCT</b> (ring detect time)	This timer must be set shorter than the on cycle for C.O. ring. It is intended to prevent noise on the C.O. line from triggering a false ring.	100~2500 msec

**NOTE :** Display shows second millisecond as MS, and minute as MI.

**Action**

1. Press **AUTO RDL** and dial **53**
2. Press **LINE1** or **LINE2** to select the timer you want (e.g. CO SUPV)

**Display**

CLEARING: 00S

CO SUPV: 0000MS

## MMC 53

3. Dial new time (e.g. 0500)

CO SUPV: 0500MS

4. Press **AUTO RDL** to save and exit

**DEFAULT DATA**

CLEARING	: 00 SEC
CO SUPV	: 0000 MSEC
F DGT DLY	: 1000 MS
FLASH PBX	: 0600 MSEC
MFS ON TM	: 0100 MSEC
MF OFF TM	: 0100 MSEC
MPD DETCT	: 40 MSEC
NEW CALL	: 2000 MSEC
NO RING	: 05 SEC
PAUSE TM	: 03 SEC
RNG DETCT	: 0200 MSEC

**RELATED MMC**

NONE

**MMC 54****MAKE/BREAK RATIO****Description:**

Allows the ability to change the duration of the make/break time. This will only affect rotary dial trunks.

**Action**

1. Press **AUTO RDL** and dial **54**
2. Enter the MAKE/BREAK ratio via the KEYPAD (e.g. MAKE:40 BREAK:60)
3. Press **AUTO RDL** to save and exit

**Display**

MAKE:33 BREAK:66

MAKE:40 BREAK:60

**DEFAULT DATA**

MAKE : 33  
BREAK : 67

**RELATED MMC**

MMC 41 TRUNK DIALING TYPE

# MMC 55 CURRENT DATE AND TIME

**Description:**

Allows the system date and time to be set. This will set the system-wide clock.

<b>YY</b>	Year	00~99 (e.g. 1995;æ95)
<b>MM</b>	Month	01~12
<b>DD</b>	Date	01~31
<b>W</b>	Weekday	0~6 (0:SUN 1:MON 2:TUE 3:WED 4:THU 5:FRI 6:SAT)
<b>HH</b>	Hour	00~23
<b>MM</b>	Minute	00~59

**Action**

1. Press **AUTO RDL** and dial **55**
2. Enter current date and time using above table (e.g. 5th July 1998, Wednesday, 11:35)
3. Press **AUTO RDL** to save and exit

**Display**

YY MM DD W HH:MM

95 07 05 3 11:35

**DEFAULT DATA**

SAT 01 JAN 12:00

**RELATED MMC**

MMC 15 DATE DISPLAY

# MMC 56                      ASSIGN AUTO NIGHT TIME

**Description:**

Used to enter the system into night mode automatically. A NIGHT key is not needed as the system will switch automatically, but it is helpful to have a dedicated button so the status can be manually changed. In the display, D is the time the system will switch from night to day service and N is the time the system will switch from day to night service.

There are three types of automatic night time table: WEEK, SATURDAY and SUNDAY. Each of them is composed of two time tables. If the user wants to switch automatically twice a day, it is useful to complete the two time tables in each of the automatic night time tables.

<b>Table type</b>	<b>Description</b>
WEEK	Used for Monday through Friday
SATURDAY	Used for Saturday
SUNDAY	Used for Sunday

**Action**

**Display**

1. Press **AUTO RDL** and dial **56**

WEK1 D0000 N0000

2. Press **LINE1** or **LINE2** to select the auto night time table:

There are six tables available (WEEK1, WEEK2, SAT1, SAT2, SUN1, SUN2)

If you want to switch to the night mode twice a day, you must enter the time of two related tables (e.g. WEEK1 and WEEK2)

If you do not, the system will switch to the night mode once a day

WEK2 D0000 N0000

3. Enter the day start time and the night start time (e.g. 7:00 a.m. and 5:30 p.m.)

WEK1 D0700 N1730

Eight digits must be entered (if there are less than eight digits, data will not be changed)

## MMC 56

- 3a. If you want to switch twice a day, you must enter two related tables simultaneously (e.g. WEEK1 and WEEK2)

WEEK1 D:0700 N:1200
---------------------

AND

WEEK2 D:1300 N:1700
---------------------

4. Press **AUTO RDL** to save and exit

**DEFAULT DATA**

DAY : 0000  
NIGHT : 0000

**RELATED MMC**

MMC 55 CURRENT DATE AND TIME

**MMC 57****CALL COST****Description:**

Used to program the unit cost of the metering pulse generated by Central Office. If the MPD card is installed in the system, it will detect the metering pulse provided by the Central Exchanger and determine the call cost by the number of metering pulses and the unit cost programmed by this MMC. The unit cost is four (4) digits, measured in the lowest denomination of currency (e.g. pence in the UK).

**Action**

1. Press **AUTO RDL** and dial **57**
2. Enter 4-digit call cost.  
(If you don't enter four digits, the data will not be changed)
3. Press **AUTO RDL** to save and exit

**Display**

CALL COST: 0000

CALL COST: 0320

**DEFAULT DATA**

CALL COST : 0000  
(Range of UNIT COST is 0001-9999)

**RELATED MMC**

MMC 47 ASSIGN MPD

# MMC 60 TOLL DENY TABLE/APPLY

**Description:**  
 Allows you to define what leading digit(s) in a dialling plan are to be restricted and which class(es) should be applied in this toll deny table. Each entry can be defined by up to 11 digits.

**Acton**

**Display**

1. Press **AUTO RDL** and dial **60**

TOLL DENY : NEW

2. Press **MUTE/DND** or **MSG** to select the search class (search class = NEW, ALL, B, C, D, E)

05464602834:1111

3. Pressing **LINE1** or **LINE2** to find the desired entry or Empty entry

:BCDE

4. Enter the dial number to be restricted and press **CALLBACK** or **RDL** to assign the toll restriction apply class  
 Then dial four (4) digits:  
     **0 for NO**  
     **1 for YES**

0546            :0011

5. Press **AUTO RDL** to save and exit

**DEFAULT DATA**

NONE

**RELATED MMC**

MMC 30 STATION TOLL CLASS  
 MMC 61 TOLL ALLOW TABLE/APPLY

# MMC 61 TOLL ALLOW TABLE/APPLY

**Description:**  
 Allows you to define what leading digit(s) in a dialling plan are to be allowed and which class(es) should be applied in this toll allow table. Each entry can be defined by up to 11 digits.

**Action**

**Display**

1. Press **AUTO RDL** and dial **61**
  
2. Pressing **MUTE/DND**, select the search class  
 (search class =NEW, ALL, B,C,D,E)
  
3. Press **LINE1** or **LINE2** to find the desired entry or Empty entry
  
4. Enter the dial number to be allowed and press **CALLBACK** or **RDL** to assign the toll class  
 Then dial four (4) digits  
     **0 for NO**  
     **1 for YES**
  
5. Press **AUTO RDL** to save and exit

TOLL ALLOW: NEW

05464602834:1111

:BCDE

0546            :0011

**DEFAULT DATA**

NONE

**RELATED MMC**

- MMC 30 STATION TOLL CLASS
- MMC 60 TOLL DENY TABLE

# MMC 62 PBX ACCESS CODE

**Description:**  
 Used to identify PBX access codes so that toll restriction will work. When a PBX line is accessed, the dial tone originates in another PBX and extension numbers on that switch can be dialled.

To get an outside line, an access code must be dialled. If this access code appears in this list, it is ignored and the toll restriction plan examines the digits following the PBX access code. It has five entries (1-5) with a maximum of four digits per entry.

**Action**

**Display**

1. Press **AUTO RDL** and dial **62**

PBX1:

2. Press **LINE1** or **LINE2** to select the entry (e.g. PBX2)

PBX2:

3. Enter new PBX access code(maximum four digits, e.g. 9)

PBX1:9

4. Press **AUTO RDL** to save and exit

**DEFAULT DATA**

NONE

**RELATED MMC**

MMC 40 C.O. PBX LINE

# MMC 63 AUTHORIZATION CODE

**Description:**

Used to list all allowable authorisation codes. An authorisation code must be four digits long. There are 50 codes allowed in this table. Duplications or number conflicts are not permitted.

Each authorisation code has an associated dialling class of service. When the code is entered, the dialling class of service is changed to that of the authorisation code.

**Action**

**Display**

1. Press **AUTO RDL** and dial **63**

AU01:	COS:
-------	------

2. Enter two digits(01~50), or press **LINE1** or **LINE2** to select the entry

3. Enter 4-digit code and dialling class (e.g. 0312 end 1)

AU01:0312	COS:1
-----------	-------

There are five dialling classes

- 1 : A CLASS**
- 2 : B CLASS**
- 3 : C CLASS**
- 4 : D CLASS**

4. Press **AUTO RDL** to save and exit

**DEFAULT DATA**

NONE

**RELATED MMC**

MMC 30 STATION TOLL CLASS

**MMC 64****OVERRIDE TABLE****Description:**

Used to enter up to five exceptions to toll restriction. These exceptions can be accessed by any class in both the day and night modes. These entries are useful in allowing access to emergency numbers.

**Caution should be taken with the entries in this table because they will not be blocked for outgoing calls.**

**Action****Display**

1. Press **AUTO RDL** and dial **64**
2. Press **LINE1** or **LINE2** to select the urgent code number that you want (e.g. 911)
3. Enter the number to allow (e.g. 911)
4. Press **AUTO RDL** to store and exit

URG1:

URG2:

URG1:911

**DEFAULT DATA**

NONE

**RELATED MMC**

NONE

# MMC 65                      ASSIGN WILD CHARACTER

**Description:**  
 Provides flexibility to toll restriction when a specific numbering plan is desired. There are only three entry tables, but more than one digit can be assigned per table if needed.

**Action**

**Display**

1. Press **AUTO RDL** and dial **65**

X:111111111111

2. Press **LINE1** or **LINE2** to select the wild character(X,Y or Z, e.g. Y)

Y:111111111111

3. Enter the digit '1' under the desired digit.  
 Twelve (12)  
 Digits must be entered  
 (If there re less than 12 digits, data will not be changed)

X:000000000000

4. Press **AUTO RDL** to save and exit

**DEFAULT DATA**

```

1234567890*#
X : 111111111111
Y : 111111111111
Z : 111111111111
    
```

**RELATED MMC**

MMC 60 TOLL DENY TABLE  
 MMC 61 TOLL ALLOW TABLE

# MMC 66 SYSTEM SPD DIAL TOLL RESTRICTION

**Description:**  
 Enables you to define whether the system allows or denies long distance numbers in system speed dialling to override toll restriction.

**BYPASS TOLL** Any station can use system speed dial numbers without restriction, regardless their classes.

**FOLLOW TOLL** The system checks all the system speed dialings according to the station class and deny/allow table.

**Action**

**Display**

1. Press **AUTO RDL** and dial **66**

BYPASS TOLL

2. Press **MUTE/DND** or **MSG** to select data  
 OR  
 Dial **1** for **BYPASS TOLL**  
 or **2** for **FOLLOW TOLL**

FOLLOW TOLL

3. Press **AUTO RDL** to save and exit

**DEFAULT DATA**

BYPASS TOLL

**RELATED MMC**

- MMC 30 STATION TOLL CLASS
- MMC 60 TOLL DENY TABLE
- MMC 61 TOLL ALLOW TABLE
- MMC 67 ASSIGN SYSTEM SPEED DIAL

# MMC 67                      ASSIGN SYSTEM SPEED DIAL

**Description:**  
 Used to store up to 80 system speed dial numbers. The system speed dial number is composed of two digits (20-99) and a maximum of 30 digits per telephone number can be stored at each speed dial number. Eighty (80) system speed dial numbers are commonly used at every station and the system toll restriction is set using MMC 66. A speed dial number comprises an access code and the number to be dialed. The access code can be any trunk group, individual trunk, station group, and individual station. If you dial a valid trunk, trunk group, station or station group access number, it will automatically insert the separator (:).

**Action**

**Display**

1. Press **AUTO RDL** and dial **67**

SYS SPD TABLE:

2. Using **LINE1** or **LINE2** to select the entry  
 OR  
 Dial the entry number (20~99, e.g. 20)

20:

3. Enter the speed dial number (up to 30 digits)

20:7019P0546460

4. Enter trunk access code(e.g. 9) followed by  
 the number to be dialed(e.g. 1234567)

17:9:1234567

5. Press **LINE1** or **LINE2** to enter another speed  
 dial number and return to step 3

6. Press **AUTO RDL** to save and exit

**DEFAULT DATA**

NONE

**RELATED MMC**

NONE

## MMC 70

## DIAL NUMBERING PLAN

**Description:**

Provides the access codes and dialling plan needed for operation of features and programs. The system comes with a wide range of acceptable numbering plans set as default and the option to customise the dialling plan. There is also a confirm message provided because of the chance of duplicating an access/feature code.

**Action****Display**

1. Press **AUTO RDL** and dial **70**
2. press **MUTE/DND** or **MSG**, select the desired numbering plan group(STATION, STATION GRP, TRUNK, TRUNK, GRP or FEATURE)
3. Search the desired numbering plan entry by pressing **LINE1** or **LINE2**
4. Enter digits via the dial keypad (Max 3 digits)
5. Press **LINE1** or **LINE2** to enter change and continue to make changes  
OR  
Press **MUTE/DND** or **MSG** to enter change and continue to select numbering plan groups in step 2
- If confirm message appears indicating duplication of access code, dial  
**0 for no change**  
or **1 for change**
6. Press **AUTO RDL** to save and exit

STN09:201:

STN09:201:401

STN10:202

SGR01:500:

## MMC 70

**DEFAULT DATA**

ACC	: 47	: ACCOUNT CODE
ALM	: 58	: ALARM
AMD	: 68	: ANSWER MODE
ATH	: 65	: AUTHORIZATION CODE
BRG	: 40	: BARGE-IN
CBK	: 44	: CALL BACK
CMP	: 45	: CAMP-ON
CNF	: 46	: CONFERENCE
COS	: 59	: CLASS OF SERVICE
CPS	: 54	: CHANGE PASSCODE
DND	: 64	: DO NOT DISTURB
DOR	: 13	: DOOR
DPC	: 10	: DIRECT PICKUP
EXC	: 12	: EXECUTIVE / SECRETARY
FAT	: 14	: FORCED AUTO ANSWER
FLS	: 49	: FLASH
FWA	: 61	: CALL FORWARD ALL
FWB	: 62	: CALL FORWARD BUSY
FWC	: 60	: CALL FORWARD CANCEL
FWN	: 63	: CALL FORWARD NO ANSWER
GPC	: 66	: GROUP PICK UP
GPS	: *	: SELF GROUP PICK UP
HED	: 69	: HEADSET
HLD	: 11	: HOLD
IOG	: 53	: IN / OUT GROUP
LNR	: 19	: LAST NUMBER REDIAL
MPG	: 56	: MEET ME PAGE
MSA	: 43	: MESSAGE ANSWER
MSC	: 42	: MESSAGE CLEAR
MSL	: 41	: MESSAGE LEFT
OPR	: 0	: OPERATOR
PAG	: 55	: PAGE
REC	: 18	: DISA VOICE RECORDING
SDI	: 15	: SPEED DIAL INSERTION
SNR	: 17	: SAVED NUMBER REDIAL
SPD	: 16	: SPEED
SGR	: 500-519	: STATION GROUP
STN	: 2XX	: STATION NUMBER
TRK	: 7XX	: TRUNK NUMBER
TGR	: 9, 80-89	: TRUNK GROUP
UPC	: 67	: UNIVERSAL NIGHT ANSWER
VAC	: 48	: VACANT MESSAGE

**RELATED MMC**

ALL PROGRAM AND FEATURES

# MMC 71 SYSTEM KEY PROGRAMMING

**Description:**  
Allows for the customising of programmable keys on a system-wide basis.

**Action**

**Display**

1. Press **AUTO RDL** and dial **71**

TYPE: NX24

2. Press **LINE1** or **LINE2** to select the type of the keyset:

TYPE: NX12

3. Press the desired key  
OR  
Press **RDL** or **CONF** to select desired key. (e.g. 13)

13:NONE

4. Enter the key programming via keypad.  
Trunk number, Trunk Group number, Station number, Station Group number, or feature number can be programmed keys

13:\*26

If you want to program a feature key, you must press '\*' key  
Before entering the feature key ID (e.g. NIT : \*26)

Programmable key assignments are listed below (Default Data)

If you want to change another key, return to step 3

5. Press **AUTO RDL** to save and exit.

**DEFAULT DATA**

NX-24E/NX-24B					
19: 209	20:210	21: 211	22: 212	23: 213	24: 214
13: 203	14: 204	15: 205	16: 206	17: 207	18: 208
07: 705	08: 706	09: 707	10: 208	11: 201	12: 202
01: 701	02: 702	03: 703	04: 704	05: FLS	06: TRN

NX-6B					
01: 701	02: 702	03: 703	04: 704	05: FLS	06: TRN

**MMC 71**

<b>SKP-816</b>						
09: 201	17: 209		01: 701	02: 702	03: 703	04: 704
10: 202	18: 210		05: 705	06: 706	07: 707	08: 708
11: 203	19: 211					
12: 204	20: 212					
13: 205	21: 213					
14: 206	22: 214					
15: 207	23: 215					
16: 208	24: 216					

<b>NX-AOM</b>	
01: NONE	13: NONE
02: NONE	14: NONE
03: NONE	15: NONE
04: NONE	16: NONE
05: NONE	17: NONE
06: NONE	18: NONE
07: NONE	19: NONE
08: NONE	20: NONE
09: NONE	21: NONE
10: NONE	22: NONE
11: NONE	23: NONE
12: NONE	24: NONE

## MMC 71

**Programmable Key Assignment**

*00 :	<b>ACC</b>	Account code	*20 :	<b>IOG</b>	Group In/Out
*01 :	<b>ALM</b>	Set Alarm	*21 :	<b>LNR</b>	Last Number Redial
*02 :	<b>AMD</b>	Answer Mode	*22 :	<b>LSN</b>	Group Listening
*03 :	<b>ARD</b>	Auto Redial	*23 :	<b>MPG</b>	Meet Me Page
*04 :	<b>BRG</b>	Barge-In	*24 :	<b>MSG</b>	Message
*05 :	<b>CBK</b>	Callback	*25 :	<b>MUT</b>	Mute
*06 :	<b>CMP</b>	Camp-on	*26 :	<b>NIT</b>	Night mode
*07 :	<b>CNF</b>	Conference	*27 :	<b>OPR</b>	Operator group
*08 :	<b>DND</b>	Do Not Disturb	*28 :	<b>PAG</b>	Page
*09 :	<b>DOR</b>	Door	*29 :	<b>PSE</b>	Pause Dialing
*10 :	<b>DPC</b>	Direct Pickup	*30 :	<b>SNR</b>	Saved Number Redial
*11 :	<b>EXC</b>	Boss/Secretary	*31 :	<b>SPD</b>	Speed Dialing
*12 :	<b>FAT</b>	Forced Auto Answer	*32 :	<b>TMR</b>	Timer
*13 :	<b>FLS</b>	Flash	*33 :	<b>TRN</b>	Transfer
*14 :	<b>FWA</b>	Call Forward All	*34 :	<b>UPC</b>	UNA Pickup
*15 :	<b>FWB</b>	Call Forward Busy	*35 :	<b>VAC</b>	Vacant Message
*16 :	<b>FWE</b>	External Call Forward			
*17 :	<b>FWN</b>	Call Forward No answer			
*18 :	<b>GPC</b>	Group Pickup			
*19 :	<b>HED</b>	Headset mode			

**NOTE** : : The SPD, VAC, PAG, DOR, EXC, DPC and GPC keys can be assigned with extenders. Refer to MMC 16 KEY EXTENDER.

**RELATED MMC**

MMC 16 KEY EXTENDER  
MMC 72 STATION KEY PROGRAMMING

# MMC 72 STATION KEY PROGRAMMING

**Description:**  
 Allows for the customising of programmable keys on specific electronic keysets. This program also provides a tool for duplicating keysets (so that each has the same key format structure). A limitation is that copied and target sets must be the same type of keyset.

**Action**

**Display**

1. Press **AUTO RDL** and dial **72**

201 CPY FROM:

2. If you want to copy from another station key assignment, enter the station number(e.g. 202)

201 CPY FROM: 202

Press **LINE1/LINE2** to select the station

201 01:701

3. Press the desired key  
 OR  
 Press **RDL** or **CONF** to select desired key

201 13:NONE

4. Press dial pad key number to make selection.  
 If you want to change another key, return to step 3

201 13:\*10702

5. Press **AUTO RDL** to save and exit

**DEFAULT DATA**

Same as MMC 71

**RELATED MMC**

- MMC 16 KEY EXTENDER
- MMC 72 STATION KEY PROGRAMMING



# MMC 80 I/O PARAMETER

**Description:**

Provides a mean of setting parameters for the serial I/O ports (COM1 and COM 2) to work with SMDR and Remote MMC. COM1 and COM2 may be found on the SMDR/R-MMC card. COM1 is the SMDR port and COM2 is R-MMC port on the card. COM1 is used as SMDR or TRAFFIC port and COM2 is used for remote programming.

PARAMETER	OPTIONS
TYPE OF SERVICE	SMDR, REMOTE, TRAFFIC
REMOTE STN	REMOTE only
BAUD RATE	300, 600, 1200, 2400, 4800, 9600 BPS
CHARACTER LENGTH	7 BIT, 8 BIT
PARITY	NO PARITY, EVEN PARITY, ODD PARITY
STOP BIT	1 BIT

**Action**

**Display**

1. Press **AUTO RDL** and dial **80**

COM1:9600 8 NONE

2. Press **LINE1,LINE2** to select the serial port (COM1, COM2)

3. Press **RDL** or **CONF** to select the parameter you want

COM1:4800 8 NONE

4. Press **MUTE/DND** or **MSG** to select the data

COM1:4800 7 ODD

5. Press **AUTO RDL** to save and exit

**DEFAULT DATA**

COM1 : 9600 8 NONE  
 COM2 : 9600 8 NONE  
 COM1 : XON OFF : ON  
 COM2 : XON OFF : ON  
 SMDR : COM1  
 TRAFFIC : COM1  
 REMOTE : COM2 STN : NONE

NOTE : 'XON OFF' means whether the system checks the CTS pin of the serial port.  
 'REMOTE STN' means the port displaying the Remote MMC procedure. When remote programming is in progress, it is not possible to access this port.

**RELATED MMC**

NONE

# MMC 81 SMDR OPTION

**Description:**

Allows the system administrator to select the information to be printed on the SMDR report. The following options may be selected.

OPTIONS	DESCRIPTIONS
PAGE HEADER	Determines whether or not a page header will print at the top of each page. This feature is normally turned off if SMDR is sent to a call accounting machine.
LINE PER PAGE	Selects the length of each page to determine when to print the SMDR header. The number of lines is in the range 10-99.
INCOMING CALL	Determines whether incoming calls will print on SMDR.
AUTHORIZE CODE	Determines whether the table number of authorisation codes will print on SMDR.
LESS START TIME	Determines whether valid calls will include the minimum call time in total call duration.
ALARM	Determines whether stations receiving an alarm reminder call will print on SMDR.
COMPANY NAME	Allows the system administrator to enter a 16-character name which will appear on the SMDR header.

**Action**

**DISPLAY**

1. Press **AUTO RDL** and dial **81**

PAGE HEAD:YES

2. Press **LINE1** or **LINE2** to select the parameter you want (e.g. LINE PER PAGE)

LINE PER PAGE:66

3. Press **MUTE/DND** or **MSG** to select data  
 OR  
 Using KEYPAD, dial  
**0 for NO**  
**1 for YES**  
 For LINE PER PAGE, enter the line number(10-99)  
 For COMPANY NAME, refer to MMC 14  
 (STATION NAME)

4. Press **AUTO RDL** to save and exit

**DEFAULT DATA**

PAGE HEADER : YES  
LINE PER PAGE : 66  
INCOMING CALL : NO  
AUTHORIZE CODE : YES  
LESS START TIME : NO  
ALARM : NO  
COMPANY NAME : NONE

**RELATED MMC**

MMC 80 I/O PARAMETER

# MMC 83 CALL TRAFFIC REPORT

**Description:**

Used to print a traffic report. Four types of printing are available and each type has two options.

NO.	TYPE	DESCRIPTION
0	NO	No print
1	NOW	Printed on demand
2	DAILY	Printed at the end of day automatically (PM 12:00)
3	WEEKLY	Printed at the end of week automatically (PM 12:00 on Saturday)

NO.	OPTIONS	DESCRIPTION
0	CLEAR	A report is printed and all totals are reset to 0
1	SAVE	A report is printed and all totals are saved

**Action**

- Press **AUTO RDL** and dial **83**
- Press **MUTE/DND** or **MSG** to select type you want  
OR  
Using KEYPAD, dial  
**0 for NO**  
**1 for NOW**  
**2 for DAILY**  
or **3 for WEEKLY** (e.g. 3)
- Press **LINE1** or **LINE2** and dial  
**0 for CLEAR,**  
or **1 for SAVE** (e.g. 1)
- Press **AUTO RDL** to save and exit

**Display**

PRINT : NO

PRINT : WEEKLY

DATA: SAVE

**DEFAULT DATA :** PRINT : NO  
DATA : SAVE

**RELATED MMC :** MMC 80 I/O PARAMETER

# MMC 90 CUSTOMER USE MMC

**Description:**  
 Allows the customer to have access to certain MMCs. For example, it is advised that the customer have access to MMC 11, Call Forward, for call forwarding but it is not advised that the customer have access to MMC 60, Toll Deny for toll restriction.

**Action**

**DISPLAY**

1. Press **AUTO RDL** and dial **90**.

00:STN LOCK : YES

2. Press **LINE1** or **LINE2** to select the MMC you want.  
 OR  
 Using KEYPAD, enter the desired MMC number.

00:STN LOCK : NO

3. Press **MUTE/DND** or **MSG** to make selection.  
 (NO = Customer cannot access the MMC)

01:STN CODE: YES

4. Press **AUTO RDL** to save and exit.

**DEFAULT DATA**

- |                   |                  |
|-------------------|------------------|
| 00:STN LOCK :YES  | 20:PGM MODE :NO  |
| 01:STN CODE :YES  | 21:PGM CODE :YES |
| 10:ANS MODE :YES  | 22:CUS MISC :YES |
| 11:CALL FWD :YES  | 23:PAGE ZONE :NO |
| 12:STN MISC :YES  | 24:BARGE IN :NO  |
| 13:RING FREQ :YES | 25:HOT WARM :YES |
| 14:STN NAME :YES  | 26:ALM CLK :YES  |
| 15:DATE FORM :YES | 27:VAC MSG :YES  |
| 16:KEY EXTEN :YES | 28:CALL DISC :NO |
| 17:STN SPD :YES   | 30:STN COS :NO   |
|                   | 31:TRK USE :NO   |
|                   | 32:INTERCOM :NO  |
|                   | 33:DOOR RING :NO |

## MMC 90

34:PICK GRP	:NO	60:TOLL DENY	:NO
35:STN GRP	:NO	61:TOLL ALLOW	:NO
36:BOSS SECR	:YES	62:PBX CODE	:NO
37:SET AOM	:NO	63:AUTH CODE	:NO
38:SLT TYPE	:NO	64:URGENT CD	:NO
39:DATA LINE	:NO	65:WILD CHAR	:NO
40:PBX LINE	:NO	66:SPD TOLL	:NO
41:TRK DIAL	:NO	67:SYS SPD	:YES
42:TRK MISC	:NO	70:NUM PLAN	:NO
43:TRK RING	:NO	71:SYS KEY	:NO
44:TRK NAME	:NO	72:STN KEY	:NO
45:TRK GRP	:NO	73:KEY TEST	:NO
46:DISA LINE	:NO	80:IO PARA	:NO
47:SET MPD	:NO	81:SMDR OPT	:NO
50:SYS TIME	:NO	83:TRFC RPT	:YES
51:TONE CADE	:NO		
52:SYS CNTR	:NO		
53:TRK TIME	:NO		
54:MAKE RATE	:NO		
55:DATE TIME	:YES		
56:NITE TIME	:YES		
57:CALL COST	:NO		

**RELATED MMC**

NONE

# MMC 91 SYSTEM VERSION

**Description:**  
 Provides a display of the current software version of the KSU and the keyset, and the date when product was made. This is a READ-ONLY MMC.

**Action**

1. Press **AUTO RDL** and dial **91**.
  
2. Press **LINE1** or **LINE2** to select the display you want.
  
3. Press **AUTO RDL** to and exit.

**Display**

KSU:V1.0 EKTS:01

MADE:1996.01.01

**DEFAULT DATA**

SOFTWARE VERSION AND PRODUCT BUILD DATE

**RELATED MMC**

NONE

# MMC 92 PORT STATUS

**Description:**  
 Displays the status of a port. There are 16 status types: IDLE, BUSY, CALLBACK, DOOR RING, TRK RING, STN RING, GRP RING, RCL RING, PROGRAM, ON T HOLD, ON S HOLD, ON E HOLD, IS PAGED, IS SEIZED, WRAP UP, OFF HOOK.

<i><b>Action</b></i>	<i><b>Display</b></i>
1. Press <b>AUTO RDL</b> and dial <b>92</b> .	[702] IDLE
2. Press <b>LINE1</b> or <b>LINE2</b> to see the status of the port.	[702] BUSY
If you want to clear the port's status, press <b>HOLD</b>	[702] IDLE
3. Press <b>AUTO RDL</b> to save and exit.	

**DEFAULT DATA**

IDLE

**RELATED MMC**

NONE



**MMC 94****HALT PROCESS****Description:**

Used only in the event that all data processing needs to be stopped. A 4-digit technician's passcode is required to access this MMC. This MMC doesn't interfere with the call in progress, but when making a new call you will hear a busy tone.

**Action**

1. Press **AUTO RDL** and dial **94**.
2. Enter technician's passcode
3. Press **MUTE/DND** or **MSG** to select data.  
OR  
Using KEYPAD, dial  
**0** for **PROCESSING**  
or **1** for **HALT**  
(e.g. 0)
4. Press **AUTO RDL** to save and exit.

**Display**

PASSCODE:

PASSCODE:\*\*\*\*

PROCESSING

**DEFAULT DATA**

PROCESSING

**RELATED MMC**

NONE

# MMC 95 SYSTEM RESTART

**Description:**

Provides two methods of restarting the system.

OPTIONS	DESCRIPTION
RESET SYSTEM	It will restart the system only.
CLEAR MEMORY	It restart the system and clear all memory. If clear all memory is selected, only the default data will return.

**WARNING**

Extreme care should be taken when using this MMC. If the system is restarted, all voice/data connections are dropped. If memory is cleared, all customer data is deleted and the system returns to default status.

**Action**

1. Press **AUTO RDL** and dial **95**.
2. Enter the technician's passcode
3. Press **LINE1** or **LINE2** to select the option.  
(e.g. CLEAR MEMORY)
4. Dial 0 for NO or 1 for YES

**DISPLAY**

PASSCODE:

RESET SYSTEM?

CLEAR MEMORY?

If you selected CLEAR MEMORY you are asked to confirm your choice:

Dial **0** for **NO**  
or **1** for **YES**

ARE YOU SURE?

**DEFAULT DATA**

NONE

**RELATED MMC**

NONE

# APPENDIX

# Appendix A

## Remote Programming

Remote programming capability has been incorporated into the NX-828H via the communication (serial) R-MMC port of the optional SMDR/R-MMC card mounted on the base unit. This port is fixed as a programming port only. The remote programming capability of the NX-828H can be used to add, delete or modify a customer database. While remote programming gives added flexibility to the NX-828H, it is not possible to upload to, or download from, a disk or tape. All NX-828H MMCs may be accessed via remote programming.

### 1. Site Requirements

#### 1.1 Customer Site Requirements

Before using remote programming:

- Install the optional NX-SMDR/R-MMC card in the base unit.
- Use MMC 80 to set the baud rate of the R-MMC port of the optional NX-SMDR/R-MMC card to match the customer site's modem. Baud rate speed selections are 300, 600, 1200, 2400, 4800 and 9600. (8 Data bit, No parity, 1 stop bit is default.)
- Use MMC 80 Remote Station option: When remote programming is used, it must reference an installed NX24E keyset at the customer site. This assigned keyset will be disabled for the duration of the remote programming session. When remote programming is not in use, this assigned keyset will function as a normal keyset. No default data has been set and a keyset port selection should be made that will offer the minimal inconvenience at the job site.

**NOTE** : There are no physical connections to be made between keyset and modem or keyset and communications port. The assigned keyset is used as a software reference point only.

A customer-provided modem and cable must be connected to the R-MMC port.

- Use a voice grade dial-up line on which the modem can be called.

#### 1.2 Remote Site Requirements

- A personal computer (PC) with communications software that can emulate VT 102 terminal.

**NOTE** : Since communication software can vary, no assurance can be made that every communications software package available will work.

- An internal or external modem able to match baud rate speed with the modem at the customer site.

• A voice grade dial-up line to call the customer modem.

### 1.3 Begin Programming

Dial the customer modem number and establish a communications link with the customer site. Once communications have been established, press the TAB key on the PC keyboard and you will receive the NX-828H system header display (shown below).

```

                WELCOME TO NX SERIES REMOTE PROGRAM
                -----

                CUSTOMER   :
                DATE       : Sat, 01 , Jan
                TIME       : 00:02
                -----

                TRANSFER   : TAB
                SPEAKER    : RETURN
                UP/DOWN    : UP/DOWN
                REDIAL/FLASH: LEFT/RIGHT
                HOLD       : BACKSPACE

                PROGRAM CODE:
    
```

If you receive a "SORRY!DESTINATION PORT IS BUSY" display, the keyset assigned as the remote station in MMC 80 is currently busy and no remote programming can be done at this time. When the NX-828H system header is displayed, you can enter MMC 20, type the necessary passcode to open programming and begin the remote programming session.

### 1.4 Programming Protocol

The NX-828H will only recognise keystrokes on the PC keyboard that have been assigned as an NX-keyset equivalent. These keystrokes are fixed and are not programmable. Use the PC equivalent in place of the NX24E key as called for in MMC programming procedures. These keystrokes are described below. Dial pad numbers may be entered using the standard number keys of the PC keyboard or the number pad on the right-hand side of the PC keyboard (if equipped).

**CAUTION** : Do NOT use MMC 73 or 95 (Clear Memory option) while in remote programming. Defaulting the system will clear all necessary data needed for remote programming. Someone at the customer site will be needed to assign the necessary data for remote programming to work.

## 2. On-site Programming Via PC Terminal

On-site programming via a PC terminal has been incorporated into the NX-828H via the communication (serial) R-MMC port on the optional SMDR/R-MMC card mounted in the base unit. This port is fixed as a programming port only. The on-site programming capability of the NX-828H can be used to add, delete or modify a customer database. While on-site programming gives added flexibility to the NX-828H, it is not possible to upload to or download from a disk or tape. ALL NX-828H MMCs may be accessed via on-site programming.

### 2.1 On-site Requirements

Before on-site programming can be used:

- Install the optional SMDR/R-MMC card in the base unit.
- Use a customer-provided PC terminal with communications software that can emulate a VT 103 type terminal.

**NOTE** : Since communications software can vary, no assurance can be made that every communications software package available will work.

- Use MMC 80 to set the baud rate, Data bit, Parity bit, and Stop bit of the R-MMC port of the optional SMDR/R-MMC card to match the customer's PC terminal. Baud rate speed selections are 300, 600, 1200, 2400, 4800 and 9600. 8 bit / 7 bit data, No parity / Even parity / Odd parity, and 1 stop / 2 stop bit are selectable.
- Use MMC 80, Remote Station option: When on-site programming is used, it must reference an installed NX24 keyset at the customer site. This assigned keyset will be disabled for the duration of the on-site programming session. When on-site programming is not in use, this assigned keyset will function as a normal keyset. No default data has been set and a keyset port selection should be made that will offer the minimal inconvenience at the job site.

**NOTE** : There are no physical connections to be made between the assigned keyset and the communications port. The assigned keyset is used as a software reference point only. If the assigned keyset is a display keyset, it will echo the programming keystrokes from the PC terminal.

- A customer-provided cable must be connected between the PC terminal and the R-MMC port.

### 2.2 Begin Programming

Once communications have been established, press the TAB key on the PC keyboard and you will receive the NX-828H header display (shown below). If you receive a "SORRY DESTINATION PORT IS BUSY" display, the keyset assigned in MMC 80 is currently busy and no on-site

programming can be done at this time. When the NX-828H header is displayed, you can enter MMC 20, type the necessary passcode to open programming and begin the on-site programming session.

**NOTE** : CUSTOMER in the header will display the name assigned in MMC 81.

## **2.3 Programming Protocol**

The NX-828H will only recognise keystrokes on the PC keyboard that have been assigned as an NX24 keyset equivalent. These keystrokes are fixed and are not programmable. Use the PC equivalent in place of the NX24 key as called for in MMC programming procedures. These keystrokes are described below. Dial pad numbers may be entered using the standard number keys of the PC keyboard or the number pad on the right-hand side of the PC keyboard (if equipped).

# Appendix B

## Database Download

### 1. Introduction To Database Download Programming

A database download programming capability has been incorporated into the **NX-828** via the communication (serial) **SMDR** port of the optional **SMDR/R-MMC** card mounted in the base unit. This is a software utility designed to allow a certified **NX-828** technician the ability to perform a database download on-site.

#### 1.1 Customer Site Requirements

Certain conditions must be satisfied before installing the software package on a personal computer:

1. Install the optional **NX-SMDR/R-MMC** card in the base unit.
2. Use a 286 or higher IBM-PC or 100% IBM-compatible computer with the following
  - **MS-DOS** version 5.0 or higher
  - **MS-WINDOWS** version 3.1 or higher
  - 3 "5¼" or 5 "3½" high-density floppy drive
  - **VGA** monitor.
3. Rs-232C cable

### 2. Installing Database Downloading

#### 2.1 Getting Started

1. Create a directory to store the **DATABASE DOWNLOAD** program.
2. Copy the file to the new directory. The file is compressed and will have a name similar to **NX71229.exe** where **71229** is the date the file was generated.
3. Type "**NX71229**" to uncompress the file or Double-click file name on the file name in the Windows file manager.
4. Double-click on the icon that was created by the install program in the Windows file manager - "**NX\_DOWN.EXE**".

### 3. Setup of Database Downloading Program

#### 3.1 Starting NX Download Program

1. Connect the cable required (**RS-232C**)
2. Turn on the **PC**.
3. Enter the **DATABASE DOWNLOAD** directory.
4. Double-click on the icon that was created by the install program in the Windows - "**NX\_DOWN**"
5. You will see Windows shown below.

Figure 1.1 Main Window

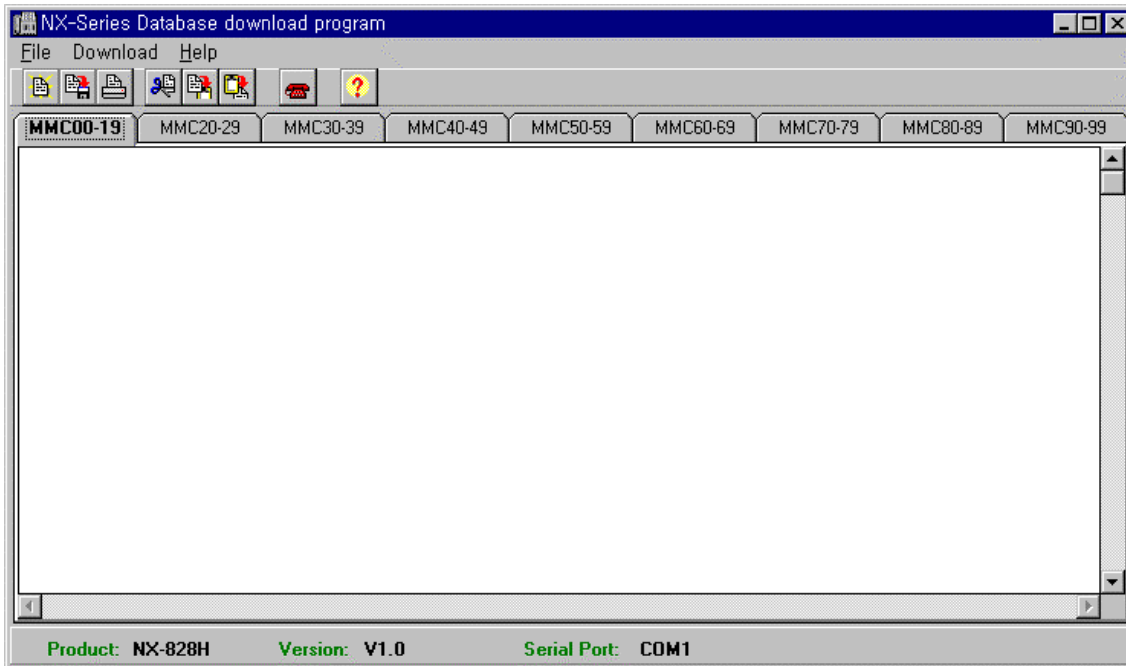

### 3. 2 Setup Of Database Downloading Program

Setup is one of the most important parts of the **DOWNLOAD PROGRAM**. Many problems can result simply from an incorrect connection. The **DATABASE DOWNLOADING** program communicates with the **NX-828** via the COM port in your computer and a port on the **NX-SMDR/R-MMC** card.

Select the required option and a check mark appears in the check box.

1. Choose Download / Version; !
2. Select the item in the Product check box
3. Select the item in the Version check box.
4. Select the item in the Country check box(optional)
5. Select OK button.

Figure 1.2 Version & Product Dialog Box



6. Choose Download / Serial Port ;
7. Check **COM** port in the Select serial port check box
8. Select OK button.

**Figure 1.2 Port dialog box**

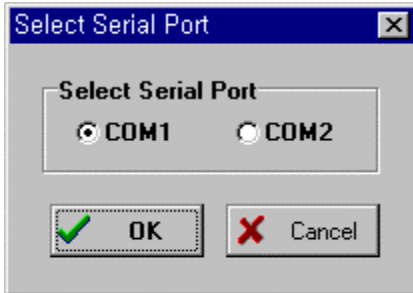

## 4. Using database downloading program

### 4.1 Downloading

1. Choose **DOWNLOAD** / Download to File ;.
2. Input file name that will contain the **MMC** data.
3. Select Download button.
4. "**DOWNLOADING...** Press ESC key to cancel" will be displayed on the screen. It will take about 15 minutes to finish database downloading.

**NOTE:**

If the download fails, recheck the setup as described above and repeat the process.  
If the Program stops during downloading, please wait for 5-10 sec, until the program restarts.

**Figure 1.4 Input File name dialog box**

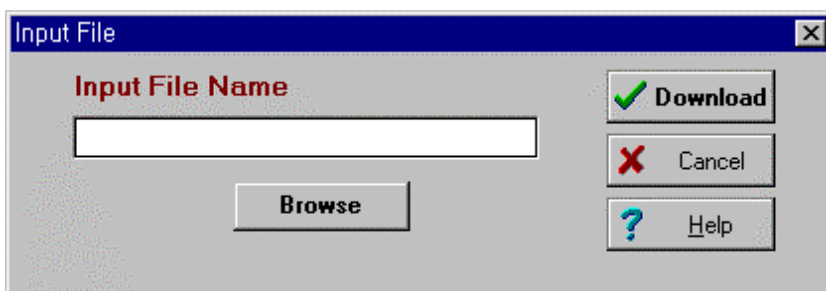

### 4.2 Open file

You can now open the downloaded database file.

1. **Click MMC** page tab that you want to see.  
or
2. You can use another editor e.g.) the built-in DOS editor, Notebook, or another Windows editor.

Figure 1.6 MMC page tab

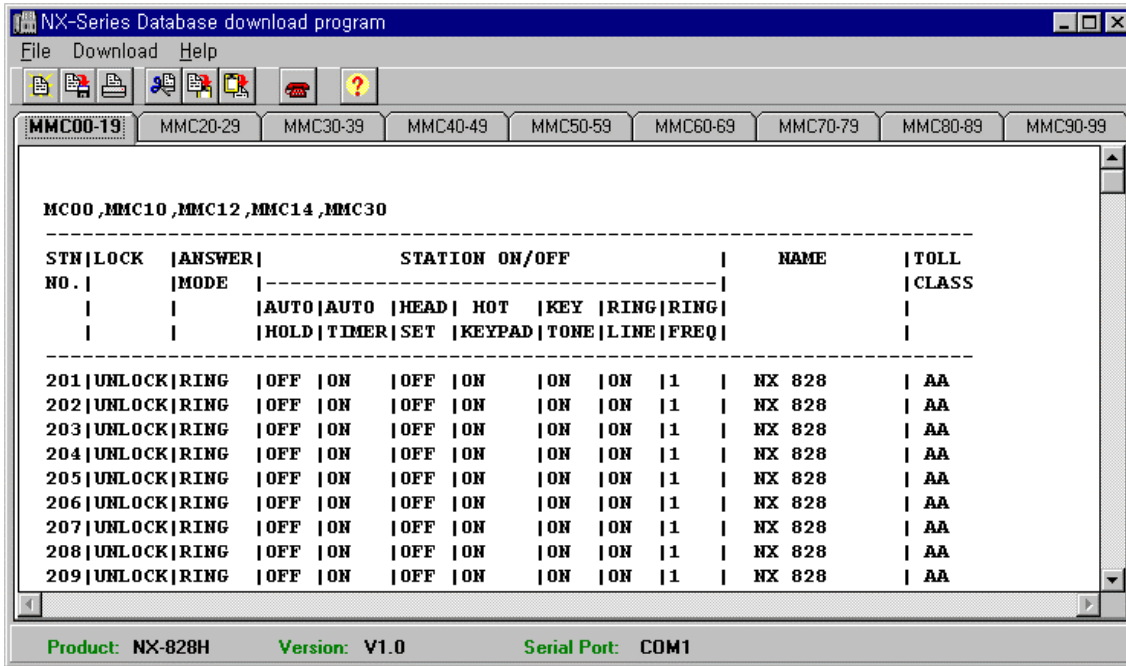

### 4.3 Save file

This option saves the downloaded file with another name with the save file option.

### 4.4 Print file

This option prints the database file that you downloaded

### 4.5 Help

This option shows the program version

# Appendix C

## DISA Voice Announcement

### 1. Automatic Answer for DISA

The system automatically answers an incoming DISA (Direct Inward System Access) call and sends a message, e.g. "This is XXX company. Extension number, please". This facilitates handling of your DISA calls and tells the calling party the status of the called extension by recorded voice message (phrase 2 or 3).

The message is approximately five seconds long (15 seconds in the case of guide information). You can record any message you want.

### 1. Phrase Configuration

PHRASE	CONTENTS	TIME
1	Guide information	15 sec
2	Busy state	5sec
3	Invalid input	5sec
4	Operator	5sec

**NOTE:**

1. If the called extension is busy, voice message (phrase 2 and 4) is sent to the calling party.
2. If the digits dialled by the calling party is an invalid number, voice message is sent to the calling party.
3. If you use this function, you should set 'VOICE MESSAGE' to 'ON' in MMC 42.

### 3. How to Record & Monitor Message

#### 3.1 Recording for Initialisation

1. Dial 18 to display 'RECORD:PLAY ?' in LCD.
2. Press 0, and record phrase 1.
3. After recording phrase 1, play phrase 1 automatically to check it.
4. Display 'RECORDING' in LCD for recording phrase 2.
5. Record phrase 2, and play phrase 2 automatically.
6. Record phrases 3-4 in the same way.

## 3.2 Recording

1. Dial 18 to display 'RECORD:PLAY ?' in LCD.
2. Select phrase number (1-4) you want to record, and display 'RECORDING' in LCD.
3. Start to record through handset or speaker phone.
4. After recording, you can automatically hear the recorded message.

**NOTE:** When you first switch on, you should record from phrase 1 to phrase 4 in order.

## 3.3 Monitoring

1. Dial 18 to display 'RECORD:PLAY ?' in LCD.
2. Select phrase number (5-8) you want to monitor, and display 'PLAYING' in LCD.

You can hear the selected message.

**NOTE:**

1. In order to change a recorded message, record a new message following procedure (1), so the message will be updated.
2. If you carry out monitoring procedure when no message is recorded, you might hear error tone.
3. You cannot record a message while a message is being played back.
4. If you stop recording prematurely, you can neither record a new message nor monitor a recorded message until the predetermined record time elapses.
5. The above procedures specify 18 to be dialled for recording. It is possible that this number might have been changed

# Appendix D

## 1. External Forward

If you want to use FWE(External Call Forward) function, you must do the following steps.

- 1.1 Make a "FWE" key in programmable key using MMC 71 or MMC 72
- 1.2 Make a key extender for "FWE" key.
  - extender number should be 00 ~ 99(speed dial list no.)
- 1.3 Store speed dial number to the speed list assigned in "FWE" extender.
  - If you make a "FWE00" key, then you must store the speed number for speed list "00".
- 1.4 Press "FWE" key, then External Call Forward is setted.

Note) External Call Forward function works only for incoming trunk call.

This means that External Call Forward is C.O to C.O call.

And External Call Forward does not work for group call.

You must assign station number in MMC 43.

Note) Each trunk line must be in for "TRK FWRD" in MMC 42.

Note) If External Call Forward is working, then C.O to C.O call is disconnected after C.O to C.O disconnect time(MMC 50).

# **BACK-UP DATA SHEETS**

***NX - 828 SYSTEM***  
**DATABASE FORMS**

CUSTOMER NAME : \_\_\_\_\_

ADDRESS : \_\_\_\_\_

\_\_\_\_\_

\_\_\_\_\_

\_\_\_\_\_

\_\_\_\_\_

\_\_\_\_\_

TELEPHONE NUMBER : \_\_\_\_\_

DATABASE CONTAINS \_\_\_\_\_ SHEETS





MMC 23		PAGE ZONE										
ZONE	ENTRY											

MMC 24		BARGE-IN										
OPTION :												
STATION NO.	BARGE-IN CLASS											

MMC 25		HOT / WARM LINE										
STATION NO.	DESTINATION	WARM LINE DELAY TIME										

MMC 26		ALARM REMINDER										
STATION NO.	ALARM NO.	ALARM TIME	DAY/DALY									

MMC 27		VACANT MESSAGE										
MESSAGE NO.	MESSAGE											

<b>MMC 31</b>		<b>TRUNK USE</b>	
STATION NO.	TRUNK NO.	DIAL	ANSWER

<b>MMC 32</b>		<b>INTERCOM USE</b>	
STATION NO.	DESTINATION STATION	USE	

<b>MMC 33</b>		<b>ASSIGN DOOR RING</b>	
DOOR NO.	DAY	NIGHT	

<b>MMC 34</b>		<b>PICKUP GROUP</b>	
GROUP NO.	MEMBER ID	STATION NO.	

PICKUP GROUP NO.				

THE MAXIMUM NUMBER OF PICKUP GROUP IS 10.  
 COPY AS NEEDED

<b>MMC 35</b>	<b>STATION GROUP</b>
---------------	----------------------

STATION GROUP NO. :							
RING	OVERFLOW TIME	TRSF. TIME	OVERFLOW PORT	TYPE			
NUMBER							

THE MAXIMUM NUMBER OF STATION GROUP IS 20.

<b>MMC 36</b>	<b>BOSS / SECRETARY</b>
---------------	-------------------------

SECRETARY	BOSS 1	BOSS 2

<b>MMC 37</b>	<b>ADD-ON MODULE</b>
---------------	----------------------

AOM	MASTER	AOM	MASTER	AOM	MASTER

<b>MMC 38</b>	<b>SLT DIALING TYPE</b>
---------------	-------------------------

STATION NO.	TYPE	STATION NO.	TYPE

<b>MMC 39</b>	<b>DATA LINE</b>
---------------	------------------

STATION NO.	VOICE / DATA	STATION NO.	VOICE / DATA

MMC 40		C.O PBX LINE	
TRUNK NO.	CO/PBX	TRUNK NO.	CO/PBX

DATA FOR TRUNK LINES									
TRUNK NO.	DIAL TYPE (41)	TRUNK ON / OFF (22)					ASSIGN RING (43)		NAME (44)
		1A2EMUL	FORWARD	PAGE RING	TOLL FREE	VOICE MSG	DAY	NIGHT	

MMC 45		TRUNK GROUP							
MODE :									
GROUP NO. :									
MEMBER :									

THE MAXIMUM NUMBER OF TRUNK GROUP IS 11.

MMC 46		ASSIGN DISA LINE	
TRUNK NO.	DISA OPTION	VOICE MSG (42)	

MMC 50		SYSTEM TIMERS			
TIMER	RANGE		DEFAULT		NEW
ALM R INT	1~250	sec	025S	sec	
ALM R DUR	1~250	sec	010S	sec	
ARDL INT	1~250	sec	045S	sec	
ARDL REAL	1~250	sec	045S	sec	
CBACK NOA	1~250	sec	030S	sec	
CO CO DIS	1~250	min	010MI	min	
DISA FDG	1~250	sec	025S	sec	
DISA IDG	1~250	sec	025S	sec	
DISA RING	1~250	sec	030S	sec	
DOOR RELS	100~2500	ms	1500MS	ms	
DOR R OFF	1~250	sec	030S	sec	
FIRST DGT	1~250	sec	025S	sec	
HOOK OFF	100~2500	ms	0200MS	ms	
INTER DGT	1~250	sec	025S	sec	
MMC OUT	10~250	sec	030S	sec	
OFF R INT	1~250	sec	015S	sec	
PAGE MAX	1~250	sec	020S	sec	
RCAL DISC	1~250	ms	002MI	ms	
RCAL RING	0~250	sec	015S	sec	
RCAL WAIT	0~250	sec	015S	sec	
RCAL HOLD	0~250	sec	045S	sec	
RCAL TRSF	0~250	sec	045S	sec	
SLT F MIN	10~2500	ms	0100MS	ms	
SLT F MAX	10~2500	ms	0400MS	ms	
SMDR PULAS	1~250	sec	030S	sec	
SMDR DTMF	0~250	sec	015S	sec	

MMC 51		TONE / RING CADENCE			
TONE/RING	ON	OFF	ON	OFF	

<b>MMC 52</b>		<b>SYSTEM WIDE COUNTER</b>	
OPTION		COUNTER	

<b>MMC 53</b>		<b>TRUNK WIDE TIMER</b>			
TIMER	RANGE		DEFAULT		NEW
CLEARING	1~25	sec	00	sec	
CO SUPV	100~2500	ms	0000	ms	
F DGT DLY	100~2500	ms	1000	ms	
FLASH PBX	100~2500	ms	0600	ms	
MFS ON TM	100~2500	ms	0100	ms	
MF OFF TM	100~2500	ms	0100	ms	
NEW CALL	100~9900	ms	2000	ms	
NO RING	1~250	sec	05	sec	
PAUSE TM	1~250	sec	003	sec	
RNG DETCT	100~2500	ms	0200	ms	

<b>MMC 54</b>		<b>MAKE / BREAK RATIO</b>	
MAKE :		BREAK :	

<b>MMC 56</b>		<b>ASSIGN AUTO NIGHT TIME</b>	
TABLE TYPE :			
SUB-TABLE NO.	DAY	NIGHT	

<b>MMC 57</b>		<b>CALL COST</b>	
UNIT COST :			

MMC 60					TOLL DENY TABLE / APPLY				
ENTRY	APPLY				ENTRY	APPLY			
	B	C	D	E		B	C	D	E

MMC 61					TOLL ALLOW TABLE / APPLY				
ENTRY	APPLY				ENTRY	APPLY			
	B	C	D	E		B	C	D	E

MMC 62		PBX ACCESS CODE	
PBX NO.	CODE	PBX	CODE

MMC 63			AUTHORISATION CODE		
NO.	CODE	CLASS	NO.	CODE	CLASS

<b>MMC 64</b>		<b>OVERRIDE TABLE</b>			
NO.	CODE	NO.	CODE	NO.	CODE

<b>MMC 65</b>		<b>WILD CHARACTER</b>			
X :		Y :		Z :	

<b>MMC 67</b>		<b>ASSIGN SYSTEM SPEED DIAL</b>			
NO.	SPEED DIAL NO.	NO.	SPEED DIAL NO.	NO.	SPEED DIAL NO.

<b>MMC 70</b>		<b>DIAL NUMBERING PLAN</b>			
ENTRY	ACCESS CODE	ENTRY	ACCESS CODE	ENTRY	ACCESS CODE

<b>MMC 71 / 72</b>		<b>KEY PROGRAMMING</b>			
--------------------	--	------------------------	--	--	--

<b>NX-24E/NX-24B</b>					
19:	20:	21:	22:	23:	24:
13:	14:	15:	16:	17:	18:
07:	08:	09:	10:	11:	12:
01:	02:	03:	04:	05:	06:

<b>NX-6B</b>					
01:	02:	03:	04:	05:	06:

<b>SKP-816</b>						
09:	17:		01:	02:	03:	04:
10:	18:		05:	06:	07:	08:
11:	19:					
12:	20:					
13:	21:					
14:	22:					
15:	23:					
16:	24:					

<b>NX-AOM</b>	
01:	13:
02:	14:
03:	15:
04:	16:
05:	17:
06:	18:
07:	19:
08:	20:
09:	21:
10:	22:
11:	23:
12:	24:

<b>MMC 80</b>		<b>IO PARAMETER</b>					
COM1	COM2	XON OFF		SMDR	REMOTE		TRAFFIC
		COM1	COM2		PORT	STN	

<b>MMC 81</b>		<b>SMDR OPTION</b>				
PAGE HEADER	LINE PER PAGE	INCOMING CALL	AUTHORX E CODE	LESS START TIME	ALARM	COMPANYN AME



**ELECTRONICS**